

# Catalogue

Plant Labelling  
Safety Identification



# Foreword



Labelling Solutions. Made by Stell – Comprehension. Safety. Orientation.



Dear Business Partner,

we are pleased that you are interested in our company and products. For more than 40 years, we have aimed to ensure that working environments are clear-cut and safe. With our high-quality materials and distinct industry knowledge in the fields of energy, chemicals, maritime, industry and fire protection, we are ready to serve as your qualified partner.

The new catalogue offers a comprehensive product selection when it comes to plant labelling and safety identification. With this catalogue, we are providing you with a resource to help you get to know all our products while also facilitating your selection of the product that is most suitable for you.

We are also happy to develop customised solutions for your specific requirements. Our team of experts will help you with any questions you may have.

We look forward to working with you.

Sincerely,

A handwritten signature in blue ink, appearing to read 'Jan Bernd Stell', written over a light-colored rectangular background.

Jan Bernd Stell, Managing Director of Stell GmbH

# Contents

## STELL GmbH



About the company	4
Our business approach – Labelling in a complete package	5

## Plant Labelling



Introduction	8
Original Stell “Stecksystem”	10
Printed and Engraved Signs	32
Slide-In System	36
Pipe Labelling – Stickers and Tapes	54
Tank Labelling	61
Pre-Labelling	64
Fastening and Accessories	65
Plans for Process Engineering	72



## Safety Identification



Introduction	76
Safety Way Guidance System	78
Additions to Safety Way Guidance System	82
Safety Signs	84
Safety Markings for Obstacles and Hazardous Areas	97
Floor Marking and Anti-Slip Tapes	98
Knuffi® Warning and Protection Profiles	101
Plans for Safety Identification	104
Fastening and Accessories	107



# About the Company



Since 1976, we at Stell GmbH have established ourselves as a modern group of medium-sized companies on the market for labelling and signage solutions. Providing comprehension, safety and orientation in buildings, process plants and at sea is our primary goal. High-quality materials and distinct industry knowledge in the fields of energy, chemicals, maritime, industry and fire protection ensure that the working environment is clear-cut and safe for personnel and employees.

The labelling of plants as well as safety identification are among our core competencies. As a global group of companies with branches in Germany, the Netherlands and India, we work together with our partners and customers to ensure comprehensive, effective and correct labelling solutions.

Our aim is to offer you a 100% carefree package. Our business approach allows us to offer you a one-stop-shop for all steps of the process chain. Project planning, production, on-site installation and documentation supervised by qualified consulting – our labelling solutions represent a complete package. Thanks to this approach we provide optimal coverage for all customer requirements. In addition, we have built up a

close-knit network of competent and reliable partners and suppliers to provide extra services whenever needed.

**The Stell group at a glance**

- 150 motivated employees
- more than 45 years of experience in the market
- distinct industry knowledge
- sustainable support

That's us! We look forward to meeting you.

# Our business approach – Labelling in a complete package

Current laws, regulations and standards are the focal points when it comes to labelling. By using our business approach, we ensure that as far as signage is concerned, the working environment is safe and easy to understand. Stell does much more than merely produce signs and labelling materials; we cover the entire process chain for labelling and achieve results that are precisely tailored to meet your individual needs.

The complete package includes reliable project planning, production, on-site installation and documentation. All four phases are always accompanied by the sustainable support of our employees. This approach helps you, the customer, to avoid the time-consuming task of coordinating different service providers on your own.

### Consulting

As part of our reliable service, we already advise you in advance on an independent, subject-specific basis. And also during the implementation process we will support you, answer your questions and keep you informed about the labelling process. By doing this, we are jointly able to maintain a safe and clear-cut working environment.

### Project planning

In order to establish a safe working environment, we determine the current labelling status on your premises and structures by means of an on-site evaluation. We examine your individual needs and record it as a basis to make future provisions for your equipment, the manufacture of your health and safety labelling, and/or the creation of an escape route plan. For example and after an onsite visit, we work out a list with required signs as well as labelling recommendations. We conduct discussions about necessary materials, contents, layouts and flexible installation and documentation with our customers in advance. Additionally, we carry out a check to see whether your piping and instrumentation diagrams, labelling and escape route plan are up to date after restructuring or maintenance works.

### Production

We manufacture your signs and plans in our very own production facility in Bocholt. Our dynamic manufacturing combined with direct access to our machinery allows us to tailor our production procedure to your individual order. We are glad to comply with requests for special designs and manufacture any standard product from our own warehouse in very good time. The in-house warehouse for raw materials aids us in our goal of guaranteeing flexibility and quality for our customers. Our quality is confirmed by our certificates. Complying with ISO 9001, we work according to generally recognised quality standards. In addition, our SCC certificate demonstrates distinct consideration for safety, health and environmental protection aspects.

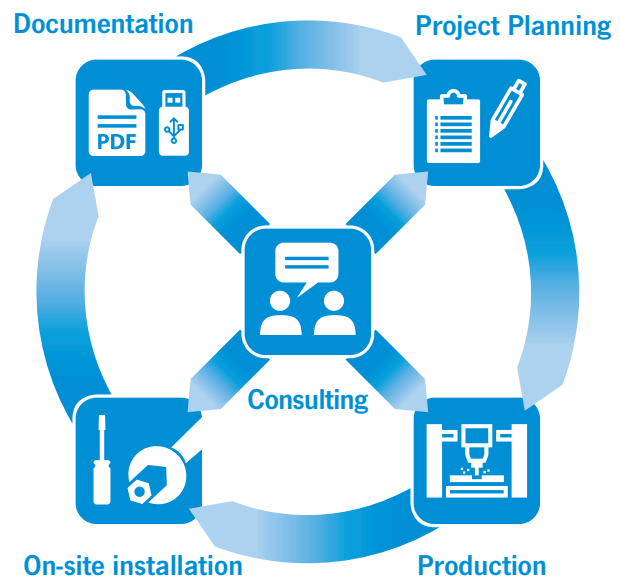

### On-site installation

Various sign-, fastening- and product variants are presented, installed, tested and approved by our expert staff. Our own installation crew possess comprehensive background knowledge as well as an acute awareness of industry specifics and process engineering for plants. They are therefore able to work independently at your site and spare you the use of scarce resources. This of course isn't the only option, as we will gladly leave the on-site installation in your hands after the project planning and production is complete. We can also provide you with a supervisor who will help to ensure that your work meets the Stell quality standard.

### Documentation

Our insistence on high-quality work obliges us to keep detailed documentation of the on-site situation. Whether by handwriting, Excel or CAD, we document the steps of our labelling work and make them available to you on request. We draw up P&ID revision work according to DIN EN ISO 10628 as well as final drawings that include attribute allocation. Furthermore, we are also well-versed when it comes to compiling fire prevention plans.

# Stell Inspections App



Inspection, Service and Maintenance – efficient and reliable



## Maintenance 4.0 – mobility thanks to Stell!

With the new Stell Inspections App you can use your mobile gadget for any kind of maintenance works. Thanks to our Auto-ID-Signs you can label your plant components and equipment and seamlessly connect them with modern systems. The customizable templates of our App will guide your technicians through all working steps that need to be carried out.

## Your benefits



NFC and RFID ready Stell signs allow for digital processing



Auto-ID-Components provide fault-free data acquisition for enhanced processing reliability



Staff, App and signs form a closed work cycle



Saving resources by paperless processing



Increased efficiency by real-time evaluation of results

Want to know more? Get in contact with us today!

# Plant Labelling

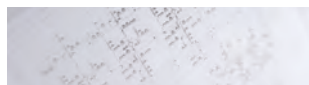

<b>Introduction</b>	<b>8</b>
<hr/>	
<b>Original Stell “Stecksystem”</b>	<b>10</b>
Symbol count and distance of observation	12
45 Series	14
06 Series	18
09 Series	22
18 Series	26
<hr/>	
<b>Printed and Engraved Signs</b>	<b>32</b>
Engraved Signs, Printed Signs	32
InSTELLigent – Signs with Barcode, Data Matrix and RFID	34
<hr/>	
<b>Slide-In System</b>	<b>36</b>
06/09 Series	40
18 Series	43
27 Series	47
36 Series	51
<hr/>	
<b>Pipe Labelling – Stickers and Tapes</b>	<b>54</b>
Pipe markers	55
Colour tapes	56
Arrow tapes	57
Text tapes	58
GHS tapes / Hazardous Substance Tapes	59
Module system and adhesive film stickers	60
<hr/>	
<b>Tank Labelling</b>	<b>61</b>
<hr/>	
<b>Pre-Labeling</b>	<b>64</b>
<hr/>	
<b>Fastening and Accessories</b>	<b>65</b>
<hr/>	
<b>Plans for Process Engineering</b>	<b>72</b>

# Introduction



To achieve clear understanding and sustainable work in energy and chemical plants, a distinct knowledge of plant components, pipes, tanks, containers is necessary. These days, straightforward plant labelling is indispensable.

In order to create a safe and comprehensive work environment it needs suitable planning, correct choice of the required labelling and professional fastening of the signs – which Stell offers as a complete package. During the planning phase we evaluate the on-site situation and the existing documentation. Should the required documentation, e.g. sign lists or up-to-date P&IDs, not be available we'll be happy to compile these for you, already taking into consideration the best choice of products and fastening materials. During the next phase, our expert staff independently carries out the labelling in a safe and professional manner for you. All of these tasks are included in the labelling project documentation (also in digital form of your choice) that will be handed out to you upon completion of the project or agreed parts of the project.

Thanks to a sophisticated product range, we are able to aid in providing comprehension and efficiency at your location. Whether specific identification Systems for Power Stations (KKS), plant labelling systems or customer coding, our signs permanently and concisely display essential information, facilitate communication and serve as a visual aid for you and your employees in your daily work. In addition, proper plant labelling helps to prevent operator errors or accidents and reduces the operating, maintenance and servicing costs throughout the entire service life.

## Compulsory labelling and its implementation – standards and laws

Plant labelling is either regulated by international law in its various areas of application, or existing standards apply as directives. In Europe, safety-relevant labels are required by law – especially at the workplace. In addition to the above mentioned identification Systems for Power Stations (KKS) or its successors – the Reference Designation System for Power Plants and plant labelling system – there are further regulations, standards and laws which are crucial to plant labelling.

Generally, plant labelling requires the labelling to be concise and in accordance with the latest technological standards.

Our labelling is designed according to German standard DIN 2403 (see graphic 1) as well as Germany's Gefahrstoffverordnung (GefStoffV, see graphic 2), or "Ordinance on Hazardous Substances", and can be adapted to your individual needs.

We would be pleased to advise you on your labelling obligations, functional set-ups and our in-house labelling systems.

**Graphic 1** Group and additional colour of the fluid content (DIN 2403)

Application	Oxygen	Water	Steam	Air	Flammable gases	Non flammable gases	Acids	Alkalis	Flammable liquids and fixed materials	Non flammable liquids and fixed materials
Group colour	RAL5005	RAL6032	RAL3001	RAL7004	RAL1003	RAL1003	RAL2010	RAL4008	RAL8002	RAL8002
Additional colour	–	–	–	–	RAL3001	RAL9004	–	–	RAL3001	RAL9004
Text colour	RAL9003*	RAL9003*	RAL9003*	RAL9004	RAL9004	RAL9004	RAL9004	RAL9003*	RAL9003*	RAL9003*

\* white



**Grafic 2** CLP/GHS Pictogram Symbols and Hazard Classes



**How to label according to German DIN standards**

With DIN 2403, the German Institute for Standardization defines the currently valid technology standard for labelling pipes according to their content for above ground pipes on land. In DIN 2403, the following components are defined as compulsory minimum specifications:

- Group and additional colour of the content
- Flow direction
- Indication of the fluid content

Other indicators (pressure, temperature, etc.) are optional.

Furthermore, the standard specifies how large a label should be depending on its distance of observation, and it makes several labelling recommendations that should be followed.

**Specify the correct distance of observation**

A formula is used for calculating and deciding on a label's size (Grafic 3) and the font height.

$$D = h \times Z$$

**Whereby:**

D = the distance of observation,

h = the font height,

Z = the distance factor.

300 for letters and numbers

100 for fire protection signs

40 for hazard symbols

For us, the distance of observation is determined on two levels. Either the correct font height can be calculated from the desired distance of observation on site, or, depending on the maximum distance of observation, the correct installation location for the labelling can be determined from the potential font height at the site.

**Grafic 3** Example distance of observation (Scale 1:1)

**A** Distance of observation (D) text = 1,5 m



**B** Distance of observation (D) GHS symbol = 1,5 m



## Original Stell "Stecksystem"



The original Stell "Stecksystem" is a patented product for plant labelling that is specially designed for the labelling of components. Consisting of a sign-bracket, a slide-in profile, individually insertable symbols (letters, numbers etc.) and outer elements, the "Stecksystem" allows you to individually handle and design your sign. All symbols can be exchanged and contents can be adjusted when required.

Codings and information are flexibly compiled as individual symbols and can be supplemented with hazardous substance or GHS pictograms, the medium's desired flow direction and its group colour in accordance with DIN 2403. The "Stecksystem" is available in various series which can be ideally combined, regardless of size.

Two material designs are available for all series. Our trademark Luxotherm® plastic offers tremendous resistance against UV radiation and contains zero chlorides. All symbols and slide-in profiles are also available as aluminium versions should temperatures in the application area be higher. On request, the original Stell "Stecksystem" can be delivered with the necessary fastening material.

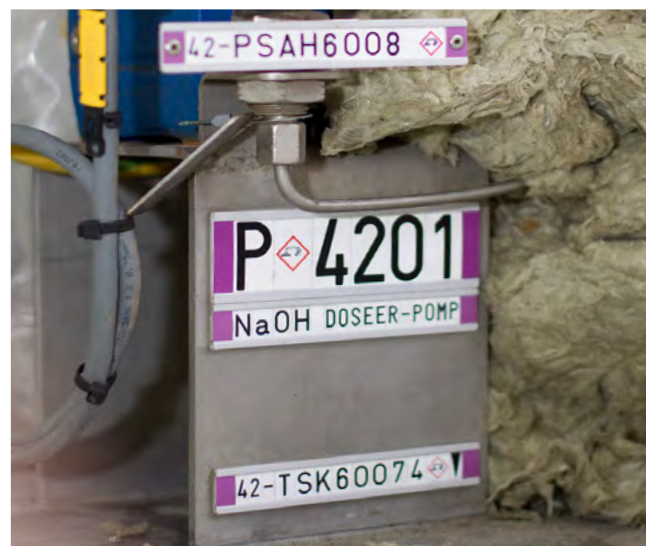

**18 series**

Slide-in profile = 126 mm, half outer elements

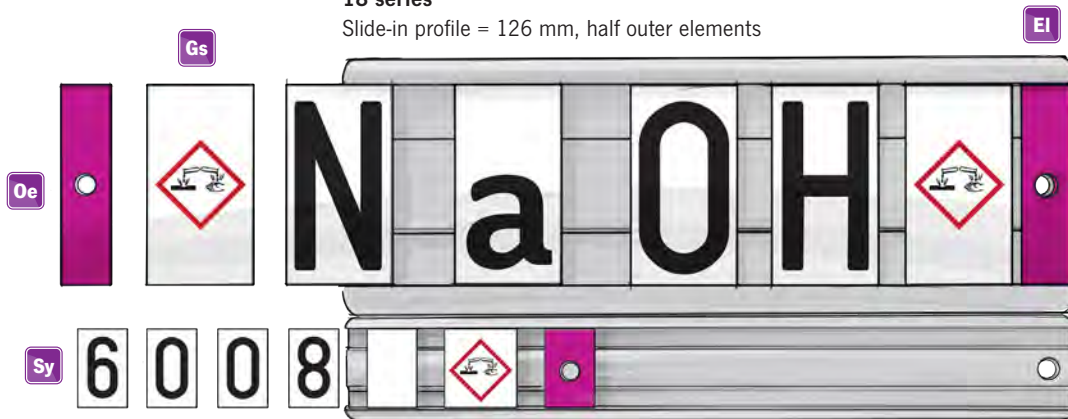

**06/09 series**

Slide-in profile = 126 mm, full outer elements

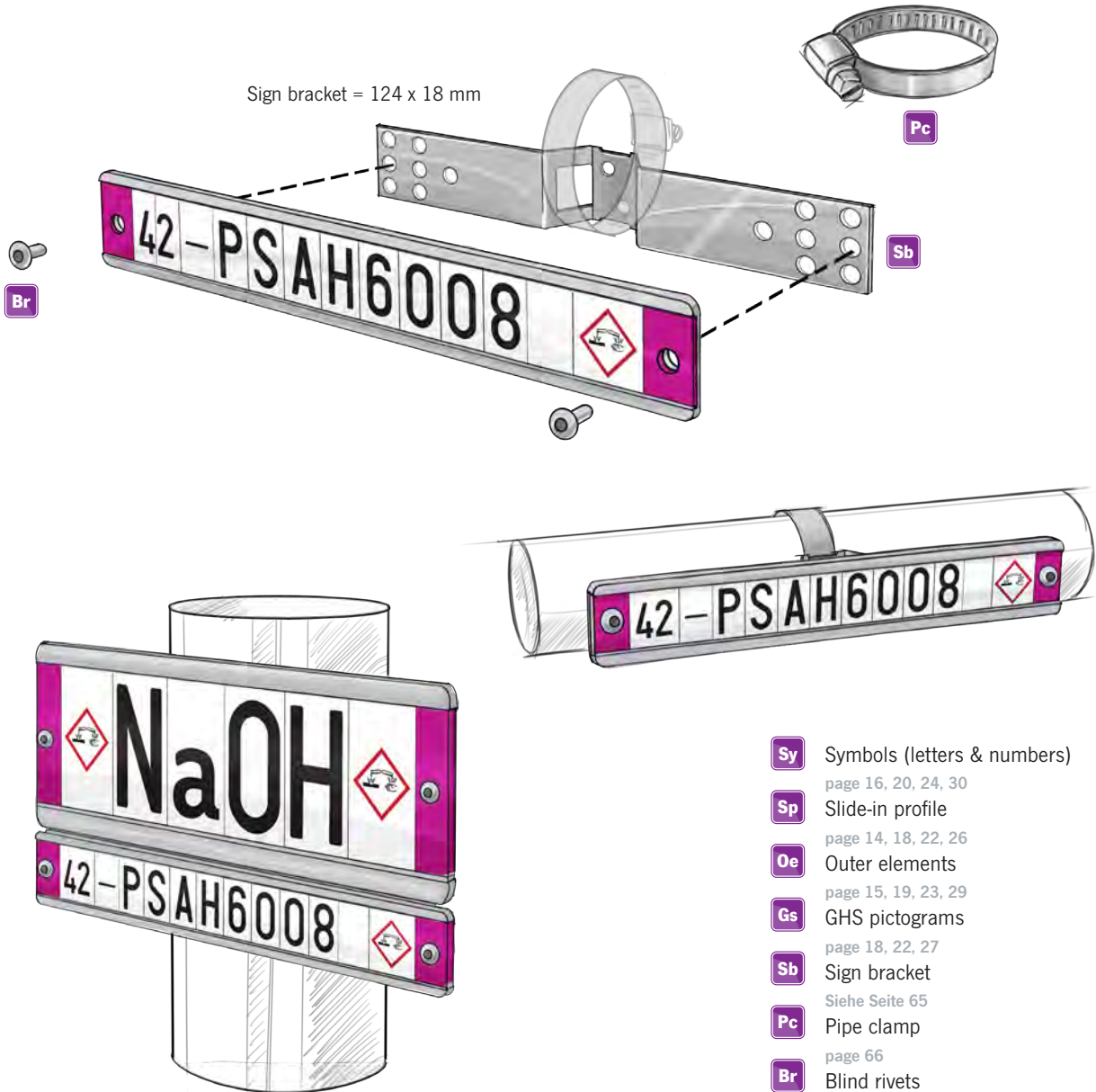

- Sy** Symbols (letters & numbers)  
page 16, 20, 24, 30
- Sp** Slide-in profile  
page 14, 18, 22, 26
- Oe** Outer elements  
page 15, 19, 23, 29
- Gs** GHS pictograms  
page 18, 22, 27
- Sb** Sign bracket  
Siehe Seite 65
- Pc** Pipe clamp  
page 66
- Br** Blind rivets  
page 68







### Symbol count and distance of observation

As the height of the font determines the distance of observation of your sign we offer the "Stecksystem" in different series, providing good visibility at close and long range. Having determined the required distance of observation and the corresponding font height you will now have to choose the number of symbols.

The overview shows how many characters and symbols will fit in a slide-in profile of a given length. Additionally, on the right side you can find a few examples of possible combinations of these series and the integration of special symbols as e.g. the GHS pictograms.

### Possible combinations of the "Stecksystem" series

	45 series	06 series	09 series	18 series
				
<b>Font height</b>	5 mm	8 mm	10 mm	30 mm
<b>Observation distance</b>	<b>1,5 m</b>	<b>2,4 m</b>	<b>3 m</b>	<b>9 m</b>

Slide-in profile	Symbol count (with full outer elements)			
45 mm	6	-	-	-
54 mm	8	-	-	-
63 mm	10	-	-	-
72 mm	12	9	6	2 / 3*
81 mm	14	-	-	-
90 mm	16	12	8	3 / 4*
99 mm	18	-	-	-
108 mm	20	15	10	4 / 5*
126 mm	24	18	12	5 / 6*
144 mm	28	21	14	6 / 7*
162 mm	32	24	16	7 / 8*
180 mm	36	27	18	8 / 9*
198 mm	-	30	20	9 / 10*
216 mm	-	33	22	10 / 11*
234 mm	-	36	24	11 / 12*
252 mm	-	39	26	12 / 13*
270 mm	-	42	28	13 / 14*
288 mm	-	45	30	14 / 15*
306 mm	-	48	32	15 / 16*
324 mm	-	51	34	16 / 17*
342 mm	-	-	-	17 / 18*
360 mm	-	-	-	18 / 19*

- = length not available

\*half outer elements

 = example on page 13

Examples in original size

45 series



06 series

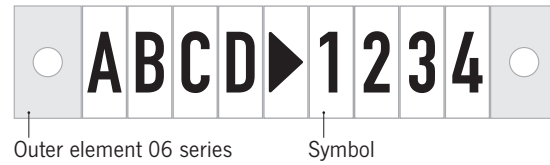

09 series

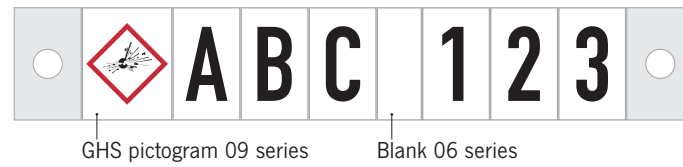
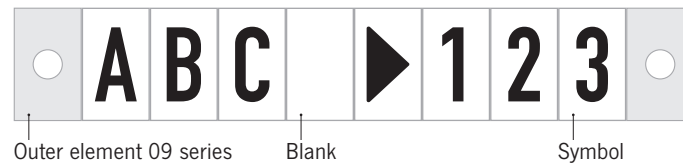

18 series

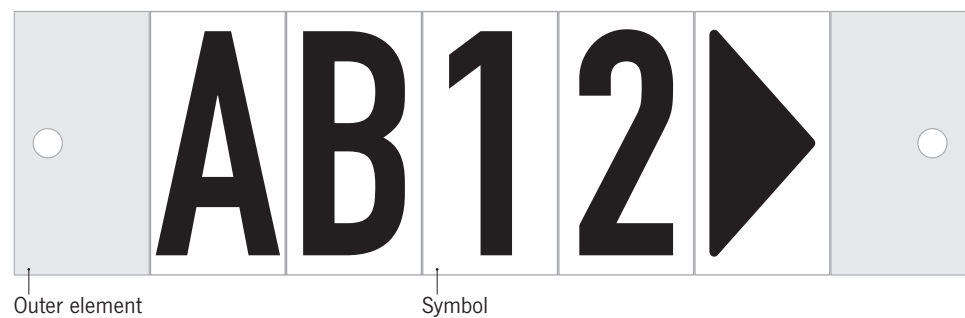

## 45 Series

Distance of observation 1,5 m

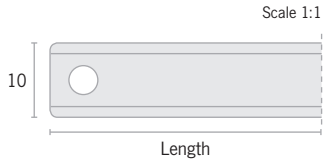

### Sp Slide-in profile

Material		Quantity	Article		
Chlorid free plastic <b>K</b> / Aluminium, anodised <b>A</b>		5 pieces	0002		
Length	Number of symbols*	Order-No.	Price	Order-No.	Price
45 mm	6	<b>K</b> 2061	€ 1,45	<b>A</b> 2049	€ 2,30
54 mm	8	<b>K</b> 2062	€ 1,60	<b>A</b> 2050	€ 2,45
63 mm	10	<b>K</b> 2063	€ 1,75	<b>A</b> 2051	€ 2,60
72 mm	12	<b>K</b> 2064	€ 1,90	<b>A</b> 2052	€ 2,75
81 mm	14	<b>K</b> 2065	€ 2,05	<b>A</b> 2053	€ 2,90
90 mm	16	<b>K</b> 2066	€ 2,20	<b>A</b> 2054	€ 3,05
99 mm	18	<b>K</b> 2067	€ 2,35	<b>A</b> 2055	€ 3,20
108 mm	20	<b>K</b> 2068	€ 2,50	<b>A</b> 2056	€ 3,35
126 mm	24	<b>K</b> 2069	€ 2,80	<b>A</b> 2057	€ 3,65
144 mm	28	<b>K</b> 2070	€ 3,10	<b>A</b> 2058	€ 3,95
162 mm	32	<b>K</b> 2071	€ 3,40	<b>A</b> 2059	€ 4,25
180 mm	36	<b>K</b> 2072	€ 3,70	<b>A</b> 2060	€ 4,55

\*The number of symbols takes into account that 2 outer elements are always added.

### Fastening

Find the suitable fastening from our system starting on page 65

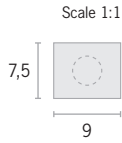

**Oe** Outer elements

Material	Quantity	Article
Luxotherm® L / Aluminium, anodised A	15 pieces	0001

DIN 2403		No colour	Oxygen	Water	Steam	Air
Design	Mat.	Neutral	Group 0	Group 1	Group 2	Group 3
without hole	Order-No. Price	<b>L</b> 2338 € 0,95	2322 € 0,95	2324 € 0,95	2326 € 0,95	2328 € 0,95
	Order-No. Price	<b>A</b> 2318 € 1,90	2302 € 1,90	2304 € 1,90	2306 € 1,90	2308 € 1,90
with hole	Order-No. Price	<b>L</b> 2337 € 0,95	2321 € 0,95	2323 € 0,95	2325 € 0,95	2327 € 0,95
	Order-No. Price	<b>A</b> 2317 € 1,90	2301 € 1,90	2303 € 1,90	2305 € 1,90	2307 € 1,90

		Gases	Acids	Alkalis	Liquids and fixed materials	Additional colour
Design	Mat.	RAL1003	RAL2010	RAL4008	RAL8002	Black
		Group 4/5	Group 6	Group 7	Group 8/9	Add on
without hole	Order-No. Price	<b>L</b> 2330 € 0,95	2332 € 0,95	2334 € 0,95	2336 € 0,95	2340 € 0,95
	Order-No. Price	<b>A</b> 2310 € 1,90	2312 € 1,90	2314 € 1,90	2316 € 1,90	2320 € 1,90
with hole	Order-No. Price	<b>L</b> 2329 € 0,95	2331 € 0,95	2333 € 0,95	2335 € 0,95	2339 € 0,95
	Order-No. Price	<b>A</b> 2309 € 1,90	2311 € 1,90	2313 € 1,90	2315 € 1,90	2319 € 1,90

NEN 3050		No colour	Steam	Fire fighting	Gases and liquid gases	Alkalis
Design	Mat.	No colour	RAL9006	RAL3000	RAL1004	RAL4001
without hole	Order-No. Price	<b>L</b> 2338 € 0,95	2372 € 0,95	2362 € 0,95	2364 € 0,95	2360 € 0,95
	Order-No. Price	<b>A</b> 2318 € 1,90	2354 € 1,90	2344 € 1,90	2346 € 1,90	2342 € 1,90
with hole	Order-No. Price	<b>L</b> 2337 € 0,95	2371 € 0,95	2361 € 0,95	2363 € 0,95	2359 € 0,95
	Order-No. Price	<b>A</b> 2317 € 1,90	2353 € 1,90	2343 € 1,90	2345 € 1,90	2341 € 1,90

		Air	Oils and flammable liquids	Acids	Water	Other liquids
Design	Mat.	RAL5012	RAL8001	RAL2008	RAL6010	Black
without hole	Order-No. Price	<b>L</b> 2366 € 0,95	2368 € 0,95	2376 € 0,95	2374 € 0,95	2340 € 0,95
	Order-No. Price	<b>A</b> 2348 € 1,90	2350 € 1,90	2358 € 1,90	2356 € 1,90	2320 € 1,90
with hole	Order-No. Price	<b>L</b> 2365 € 0,95	2367 € 0,95	2375 € 0,95	2373 € 0,95	2339 € 0,95
	Order-No. Price	<b>A</b> 2347 € 1,90	2349 € 1,90	2357 € 1,90	2355 € 1,90	2319 € 1,90

## 45 Series

Distance of observation 1,5 m

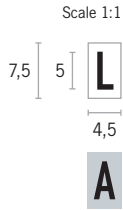

### Sy Symbols

		Material (colours)		Quantity		Article	
		Luxotherm® L (white/black) / Aluminium, anodised A (silver/black)		25 pieces		0003	

		A	a	B	b	C	c	D	d	E	e
Mat.											
Order-No.	L	1906	1939	1908	1941	1909	1942	1910	1943	1911	1944
Price	L	€ 0,85	€ 0,85	€ 0,85	€ 0,85	€ 0,85	€ 0,85	€ 0,85	€ 0,85	€ 0,85	€ 0,85
Order-No.	A	1816	1849	1818	1851	1819	1852	1820	1853	1821	1854
Price	A	€ 1,70	€ 1,70	€ 1,70	€ 1,70	€ 1,70	€ 1,70	€ 1,70	€ 1,70	€ 1,70	€ 1,70

		F	f	G	g	H	h	I	i	J	j
Mat.											
Order-No.	L	1912	1945	1913	1946	1914	1947	1915	1948	1916	1949
Price	L	€ 0,85	€ 0,85	€ 0,85	€ 0,85	€ 0,85	€ 0,85	€ 0,85	€ 0,85	€ 0,85	€ 0,85
Order-No.	A	1822	1855	1823	1856	1824	1857	1825	1858	1826	1859
Price	A	€ 1,70	€ 1,70	€ 1,70	€ 1,70	€ 1,70	€ 1,70	€ 1,70	€ 1,70	€ 1,70	€ 1,70

		K	k	L	l	M	m	N	n	O	o
Mat.											
Order-No.	L	1917	1950	1918	1951	1919	1952	1920	1953	1921	1954
Price	L	€ 0,85	€ 0,85	€ 0,85	€ 0,85	€ 0,85	€ 0,85	€ 0,85	€ 0,85	€ 0,85	€ 0,85
Order-No.	A	1827	1860	1828	1861	1829	1862	1830	1863	1831	1864
Price	A	€ 1,70	€ 1,70	€ 1,70	€ 1,70	€ 1,70	€ 1,70	€ 1,70	€ 1,70	€ 1,70	€ 1,70

		P	p	Q	q	R	r	S	s	T	t
Mat.											
Order-No.	L	1923	1956	1924	1957	1925	1958	1926	1959	1927	1960
Price	L	€ 0,85	€ 0,85	€ 0,85	€ 0,85	€ 0,85	€ 0,85	€ 0,85	€ 0,85	€ 0,85	€ 0,85
Order-No.	A	1833	1866	1834	1867	1835	1868	1836	1869	1837	1870
Price	A	€ 1,70	€ 1,70	€ 1,70	€ 1,70	€ 1,70	€ 1,70	€ 1,70	€ 1,70	€ 1,70	€ 1,70

		U	u	V	v	W	w	X	x	Y	y
Mat.											
Order-No.	L	1928	1961	1930	1963	1931	1964	1932	1965	1933	1966
Price	L	€ 0,85	€ 0,85	€ 0,85	€ 0,85	€ 0,85	€ 0,85	€ 0,85	€ 0,85	€ 0,85	€ 0,85
Order-No.	A	1838	1871	1840	1873	1841	1874	1842	1875	1843	1876
Price	A	€ 1,70	€ 1,70	€ 1,70	€ 1,70	€ 1,70	€ 1,70	€ 1,70	€ 1,70	€ 1,70	€ 1,70



		Z	z	0	1	2	3	4	5	6	7
	Mat.										
Order-No.	L	1934	1967	1982	1983	1984	1985	1986	1987	1988	1989
Price		€ 0,85	€ 0,85	€ 0,85	€ 0,85	€ 0,85	€ 0,85	€ 0,85	€ 0,85	€ 0,85	€ 0,85
Order-No.	A	1844	1877	1892	1893	1894	1895	1896	1897	1898	1899
Price		€ 1,70	€ 1,70	€ 1,70	€ 1,70	€ 1,70	€ 1,70	€ 1,70	€ 1,70	€ 1,70	€ 1,70

		8	9	2	2	3	3	4	4	!	:
	Mat.										
Order-No.	L	1990	1991	1935	1979	1936	1980	1937	1981	1903	1904
Price		€ 0,85	€ 0,85	€ 0,85	€ 0,85	€ 0,85	€ 0,85	€ 0,85	€ 0,85	€ 0,85	€ 0,85
Order-No.	A	1900	1901	1845	1889	1846	1890	1847	1891	1813	1814
Price		€ 1,70	€ 1,70	€ 1,70	€ 1,70	€ 1,70	€ 1,70	€ 1,70	€ 1,70	€ 1,70	€ 1,70

		=	+	(	)	,	.	-	▶	▲	±
	Mat.										
Order-No.	L	1905	1975	1938	1968	1969	1977	1971	1972	1973	1974
Price		€ 0,85	€ 0,85	€ 0,85	€ 0,85	€ 0,85	€ 0,85	€ 0,85	€ 0,85	€ 0,85	€ 0,85
Order-No.	A	1815	1885	1848	1878	1879	1887	1881	1882	1883	1884
Price		€ 1,70	€ 1,70	€ 1,70	€ 1,70	€ 1,70	€ 1,70	€ 1,70	€ 1,70	€ 1,70	€ 1,70

		%	/	"	□
	Mat.				
Order-No.	L	1976	1978	1992	1970
Price		€ 0,85	€ 0,85	€ 0,85	€ 0,85
Order-No.	A	1886	1888	1902	1880
Price		€ 1,70	€ 1,70	€ 1,70	€ 1,70

## 06 Series

Distance of observation 2,4 m

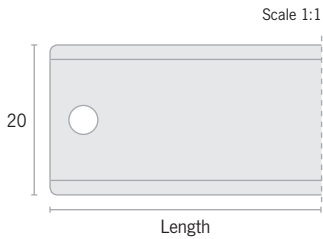

### Sp Slide-in profile

Material		Quantity	Article	
Chlorid free plastic <b>K</b> / Aluminium, anodised <b>A</b>		5 pieces	0002	
Length	Number of Symbols*	Mat.	Mat.	
72 mm	9	<b>K</b>	<b>A</b>	<b>Order-No.</b> 2008 / <b>1993</b> <b>Price</b> € 2,50 / € 3,75
90 mm	12	<b>K</b>	<b>A</b>	<b>Order-No.</b> 2009 / <b>1994</b> <b>Price</b> € 2,75 / € 4,00
108 mm	15	<b>K</b>	<b>A</b>	<b>Order-No.</b> 2010 / <b>1995</b> <b>Price</b> € 3,00 / € 4,25
126 mm	18	<b>K</b>	<b>A</b>	<b>Order-No.</b> 2011 / <b>1996</b> <b>Price</b> € 3,25 / € 4,50
144 mm	21	<b>K</b>	<b>A</b>	<b>Order-No.</b> 2012 / <b>1997</b> <b>Price</b> € 3,50 / € 4,75
162 mm	24	<b>K</b>	<b>A</b>	<b>Order-No.</b> 2013 / <b>1998</b> <b>Price</b> € 3,75 / € 5,00
180 mm	27	<b>K</b>	<b>A</b>	<b>Order-No.</b> 2014 / <b>1999</b> <b>Price</b> € 4,00 / € 5,25
198 mm	30	<b>K</b>	<b>A</b>	<b>Order-No.</b> 2015 / <b>2000</b> <b>Price</b> € 4,25 / € 5,50
216 mm	33	<b>K</b>	<b>A</b>	<b>Order-No.</b> 2016 / <b>2001</b> <b>Price</b> € 4,50 / € 5,75
234 mm	36	<b>K</b>	<b>A</b>	<b>Order-No.</b> 2017 / <b>2002</b> <b>Price</b> € 4,75 / € 6,00
252 mm	39	<b>K</b>	<b>A</b>	<b>Order-No.</b> 2018 / <b>2003</b> <b>Price</b> € 5,00 / € 6,25
270 mm	42	<b>K</b>	<b>A</b>	<b>Order-No.</b> 2019 / <b>2004</b> <b>Price</b> € 5,25 / € 6,50
288 mm	45	<b>K</b>	<b>A</b>	<b>Order-No.</b> 2020 / <b>2005</b> <b>Price</b> € 5,75 / € 7,00
306 mm	48	<b>K</b>	<b>A</b>	<b>Order-No.</b> 2021 / <b>2006</b> <b>Price</b> € 6,25 / € 7,50
324 mm	51	<b>K</b>	<b>A</b>	<b>Order-No.</b> 2022 / <b>2007</b> <b>Price</b> € 6,75 / € 8,00

\*The number of symbols takes into account that there are always two additional outer elements.  
1 GHS symbol has the same width as 2 symbols.

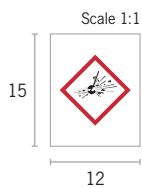

### Gs GHS pictograms

Material		Quantity	Article		
Luxotherm® <b>L</b> / Aluminium, anodised <b>A</b>		10 pieces	0003		
<b>Mat.</b>	<b>GHS 01</b>	<b>GHS 02</b>	<b>GHS 03</b>	<b>GHS 04</b>	<b>GHS 05</b>
<b>Order-No.</b>	<b>L</b> 1246	1247	1248	1249	1250
<b>Price</b>	€ 1,45	€ 1,45	€ 1,45	€ 1,45	€ 1,45
<b>Order-No.</b>	<b>A</b> 1237	1238	1239	1240	1241
<b>Price</b>	€ 2,90	€ 2,90	€ 2,90	€ 2,90	€ 2,90
<b>Mat.</b>	<b>GHS 06</b>	<b>GHS 07</b>	<b>GHS 08</b>	<b>GHS 09</b>	
<b>Order-No.</b>	<b>L</b> 1251	1252	1253	1254	
<b>Price</b>	€ 1,45	€ 1,45	€ 1,45	€ 1,45	
<b>Order-No.</b>	<b>A</b> 1242	1243	1244	1245	
<b>Price</b>	€ 2,90	€ 2,90	€ 2,90	€ 2,90	

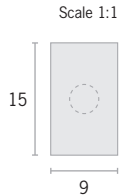

## Oe Outer elements

Material	Quantity	Article
Luxotherm® L   L Aluminium, anodised A	15 pieces	0001

DIN 2403		No Colour	Oxygen	Water	Steam	Air
Design	Mat.	Neutral	RAL5005	RAL6032	RAL3001	RAL7004
		Group 0	Group 1	Group 2	Group 3	
	<b>Order-No.</b> L	<b>41694</b>	-	-	-	-
	<b>Price</b>	€ 1,10	-	-	-	-
without hole	<b>Order-No.</b> L	<b>2110</b>	<b>2094</b>	<b>2096</b>	<b>2098</b>	<b>2100</b>
	<b>Price</b>	€ 1,10	€ 1,10	€ 1,10	€ 1,10	€ 1,10
	<b>Order-No.</b> A	<b>2090</b>	<b>2074</b>	<b>2076</b>	<b>2078</b>	<b>2080</b>
	<b>Price</b>	€ 2,20	€ 2,20	€ 2,20	€ 2,20	€ 2,20
with hole	<b>Order-No.</b> L	<b>41695</b>	-	-	-	-
	<b>Price</b>	€ 1,10	-	-	-	-
	<b>Order-No.</b> L	<b>2109</b>	<b>2093</b>	<b>2095</b>	<b>2097</b>	<b>2099</b>
	<b>Price</b>	€ 1,10	€ 1,10	€ 1,10	€ 1,10	€ 1,10
	<b>Order-No.</b> A	<b>2089</b>	<b>2073</b>	<b>2075</b>	<b>2077</b>	<b>2079</b>
	<b>Price</b>	€ 2,20	€ 2,20	€ 2,20	€ 2,20	€ 2,20

		Gases	Acids	Alkalis	Liquids & fixed materials	Additional Colour
Ausführung	Mat.	RAL1003	RAL2010	RAL4008	RAL8002	Black
		Group 4/5	Group 6	Group 7	Group 8/9	Add on
Nicht gelocht	<b>Bestellnr.</b> L	<b>2102</b>	<b>2104</b>	<b>2106</b>	<b>2108</b>	<b>2112</b>
	<b>Preis</b>	€ 1,10	€ 1,10	€ 1,10	€ 1,10	€ 1,10
	<b>Bestellnr.</b> A	<b>2082</b>	<b>2084</b>	<b>2086</b>	<b>2088</b>	<b>2092</b>
	<b>Preis</b>	€ 2,20	€ 2,20	€ 2,20	€ 2,20	€ 2,20
Gelocht	<b>Bestellnr.</b> L	<b>2101</b>	<b>2103</b>	<b>2105</b>	<b>2107</b>	<b>2111</b>
	<b>Preis</b>	€ 1,10	€ 1,10	€ 1,10	€ 1,10	€ 1,10
	<b>Bestellnr.</b> A	<b>2081</b>	<b>2083</b>	<b>2085</b>	<b>2087</b>	<b>2091</b>
	<b>Preis</b>	€ 2,20	€ 2,20	€ 2,20	€ 2,20	€ 2,20

NEN 3050		No Colour	Steam	Fire Fighting	Gases and Liquid Gases	Alkalis
Design	Mat.	No Colour	RAL9006	RAL3000	RAL1004	RAL4001
without hole	<b>Order-No.</b> L	<b>41694</b>	-	-	-	-
	<b>Price</b>	€ 1,10	-	-	-	-
	<b>Order-No.</b> L	<b>2110</b>	<b>2144</b>	<b>2134</b>	<b>2136</b>	<b>2132</b>
	<b>Price</b>	€ 1,10	€ 1,10	€ 1,10	€ 1,10	€ 1,10
	<b>Order-No.</b> A	<b>2090</b>	<b>2126</b>	<b>2116</b>	<b>2118</b>	<b>2114</b>
	<b>Price</b>	€ 2,20	€ 2,20	€ 2,20	€ 2,20	€ 2,20
with hole	<b>Order-No.</b> L	<b>41695</b>	-	-	-	-
	<b>Price</b>	€ 1,10	-	-	-	-
	<b>Order-No.</b> L	<b>2109</b>	<b>2143</b>	<b>2133</b>	<b>2135</b>	<b>2131</b>
	<b>Price</b>	€ 1,10	€ 1,10	€ 1,10	€ 1,10	€ 1,10
	<b>Order-No.</b> A	<b>2089</b>	<b>2125</b>	<b>2115</b>	<b>2117</b>	<b>2113</b>
	<b>Price</b>	€ 2,20	€ 2,20	€ 2,20	€ 2,20	€ 2,20

		Air	Oils and flammable liquids	Acids	Water	Other Liquids
Design	Mat.	RAL5012	RAL8001	RAL2008	RAL6010	Black
without hole	<b>Order-No.</b> L	<b>2138</b>	<b>2140</b>	<b>2148</b>	<b>2146</b>	<b>2112</b>
	<b>Price</b>	€ 1,10	€ 1,10	€ 1,10	€ 1,10	€ 1,10
	<b>Order-No.</b> A	<b>2120</b>	<b>2122</b>	<b>2130</b>	<b>2128</b>	<b>2092</b>
	<b>Price</b>	€ 2,20	€ 2,20	€ 2,20	€ 2,20	€ 2,20
with hole	<b>Order-No.</b> L	<b>2137</b>	<b>2139</b>	<b>2147</b>	<b>2145</b>	<b>2111</b>
	<b>Price</b>	€ 1,10	€ 1,10	€ 1,10	€ 1,10	€ 1,10
	<b>Order-No.</b> A	<b>2119</b>	<b>2121</b>	<b>2129</b>	<b>2127</b>	<b>2091</b>
	<b>Price</b>	€ 2,20	€ 2,20	€ 2,20	€ 2,20	€ 2,20

## 06 Series

Distance of observation 2,4 m

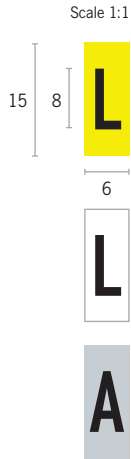

### Sy Symbols

Material (colours)												Quantity	Article
Luxotherm® <b>L</b> (yellow/black)   <b>L</b> (white/black) / Aluminium, anodised <b>A</b> (silver/black)												20 pieces	0003
		<b>A</b>	<b>a</b>	<b>B</b>	<b>b</b>	<b>C</b>	<b>c</b>	<b>D</b>	<b>d</b>	<b>E</b>	<b>e</b>		
<i>Mat.</i>													
Order-No.	<b>L</b>	1062	1128	1066	1132	1068	1134	1070	1136	1072	1138		
Price		€ 0,90	€ 0,90	€ 0,90	€ 0,90	€ 0,90	€ 0,90	€ 0,90	€ 0,90	€ 0,90	€ 0,90		
Order-No.	<b>L</b>	1063	1129	1067	1133	1069	1135	1071	1137	1073	1139		
Price		€ 0,90	€ 0,90	€ 0,90	€ 0,90	€ 0,90	€ 0,90	€ 0,90	€ 0,90	€ 0,90	€ 0,90		
Order-No.	<b>A</b>	969	1002	971	1004	972	1005	973	1006	974	1007		
Price		€ 1,80	€ 1,80	€ 1,80	€ 1,80	€ 1,80	€ 1,80	€ 1,80	€ 1,80	€ 1,80	€ 1,80		
		<b>F</b>	<b>f</b>	<b>G</b>	<b>g</b>	<b>H</b>	<b>h</b>	<b>I</b>	<b>i</b>	<b>J</b>	<b>j</b>		
<i>Mat.</i>													
Order-No.	<b>L</b>	1074	1140	1076	1142	1078	1144	1080	1146	1082	1148		
Price		€ 0,90	€ 0,90	€ 0,90	€ 0,90	€ 0,90	€ 0,90	€ 0,90	€ 0,90	€ 0,90	€ 0,90		
Order-No.	<b>L</b>	1075	1141	1077	1143	1079	1145	1081	1147	1083	1149		
Price		€ 0,90	€ 0,90	€ 0,90	€ 0,90	€ 0,90	€ 0,90	€ 0,90	€ 0,90	€ 0,90	€ 0,90		
Order-No.	<b>A</b>	975	1008	976	1009	977	1010	978	1011	979	1012		
Price		€ 1,80	€ 1,80	€ 1,80	€ 1,80	€ 1,80	€ 1,80	€ 1,80	€ 1,80	€ 1,80	€ 1,80		
		<b>K</b>	<b>k</b>	<b>L</b>	<b>l</b>	<b>M</b>	<b>m</b>	<b>N</b>	<b>n</b>	<b>O</b>	<b>o</b>		
<i>Mat.</i>													
Order-No.	<b>L</b>	1084	1150	1086	1152	1088	1154	1090	1156	1092	1158		
Price		€ 0,90	€ 0,90	€ 0,90	€ 0,90	€ 0,90	€ 0,90	€ 0,90	€ 0,90	€ 0,90	€ 0,90		
Order-No.	<b>L</b>	1085	1151	1087	1153	1089	1155	1091	1157	1093	1159		
Price		€ 0,90	€ 0,90	€ 0,90	€ 0,90	€ 0,90	€ 0,90	€ 0,90	€ 0,90	€ 0,90	€ 0,90		
Order-No.	<b>A</b>	980	1013	981	1014	982	1015	983	1016	984	1017		
Price		€ 1,80	€ 1,80	€ 1,80	€ 1,80	€ 1,80	€ 1,80	€ 1,80	€ 1,80	€ 1,80	€ 1,80		
		<b>P</b>	<b>p</b>	<b>Q</b>	<b>q</b>	<b>R</b>	<b>r</b>	<b>S</b>	<b>s</b>	<b>T</b>	<b>t</b>		
<i>Mat.</i>													
Order-No.	<b>L</b>	1096	1162	1098	1164	1100	1166	1102	1168	1104	1170		
Price		€ 0,90	€ 0,90	€ 0,90	€ 0,90	€ 0,90	€ 0,90	€ 0,90	€ 0,90	€ 0,90	€ 0,90		
Order-No.	<b>L</b>	1097	1163	1099	1165	1101	1167	1103	1169	1105	1171		
Price		€ 0,90	€ 0,90	€ 0,90	€ 0,90	€ 0,90	€ 0,90	€ 0,90	€ 0,90	€ 0,90	€ 0,90		
Order-No.	<b>A</b>	986	1019	987	1020	988	1021	989	1022	990	1023		
Price		€ 1,80	€ 1,80	€ 1,80	€ 1,80	€ 1,80	€ 1,80	€ 1,80	€ 1,80	€ 1,80	€ 1,80		
		<b>U</b>	<b>u</b>	<b>V</b>	<b>v</b>	<b>W</b>	<b>w</b>	<b>X</b>	<b>x</b>	<b>Y</b>	<b>y</b>		
<i>Mat.</i>													
Order-No.	<b>L</b>	1106	1172	1110	1176	1112	1178	1114	1180	1116	1182		
Price		€ 0,90	€ 0,90	€ 0,90	€ 0,90	€ 0,90	€ 0,90	€ 0,90	€ 0,90	€ 0,90	€ 0,90		
Order-No.	<b>L</b>	1107	1173	1111	1177	1113	1179	1115	1181	1117	1183		
Price		€ 0,90	€ 0,90	€ 0,90	€ 0,90	€ 0,90	€ 0,90	€ 0,90	€ 0,90	€ 0,90	€ 0,90		
Order-No.	<b>A</b>	991	1024	993	1026	994	1027	995	1028	996	1029		
Price		€ 1,80	€ 1,80	€ 1,80	€ 1,80	€ 1,80	€ 1,80	€ 1,80	€ 1,80	€ 1,80	€ 1,80		

		Z	z	0	1	2	3	4	5	6	7
	Mat.										
<b>Order-No.</b>	<b>L</b>	1118	1184	1214	1216	1218	1220	1222	1224	1226	1228
<b>Price</b>		€ 0,90	€ 0,90	€ 0,90	€ 0,90	€ 0,90	€ 0,90	€ 0,90	€ 0,90	€ 0,90	€ 0,90
<b>Order-No.</b>	<b>L</b>	1119	1185	1215	1217	1219	1221	1223	1225	1227	1229
<b>Price</b>		€ 0,90	€ 0,90	€ 0,90	€ 0,90	€ 0,90	€ 0,90	€ 0,90	€ 0,90	€ 0,90	€ 0,90
<b>Order-No.</b>	<b>A</b>	997	1030	1045	1046	1047	1048	1049	1050	1051	1052
<b>Price</b>		€ 1,80	€ 1,80	€ 1,80	€ 1,80	€ 1,80	€ 1,80	€ 1,80	€ 1,80	€ 1,80	€ 1,80

		8	9	2	2	3	3	4	4	!	:
	Mat.										
<b>Order-No.</b>	<b>L</b>	1230	1232	1120	1208	1122	1210	1124	1212	1056	1058
<b>Price</b>		€ 0,90	€ 0,90	€ 0,90	€ 0,90	€ 0,90	€ 0,90	€ 0,90	€ 0,90	€ 0,90	€ 0,90
<b>Order-No.</b>	<b>L</b>	1231	1233	1121	1209	1123	1211	1125	1213	1057	1059
<b>Price</b>		€ 0,90	€ 0,90	€ 0,90	€ 0,90	€ 0,90	€ 0,90	€ 0,90	€ 0,90	€ 0,90	€ 0,90
<b>Order-No.</b>	<b>A</b>	1053	1054	998	1042	999	1043	1000	1044	966	967
<b>Price</b>		€ 1,80	€ 1,80	€ 1,80	€ 1,80	€ 1,80	€ 1,80	€ 1,80	€ 1,80	€ 1,80	€ 1,80

		=	+	(	)	,	.	-	▶	▲	±
	Mat.										
<b>Order-No.</b>	<b>L</b>	1060	1200	1126	1186	1188	1204	1192	1194	1196	1198
<b>Price</b>		€ 0,90	€ 0,90	€ 0,90	€ 0,90	€ 0,90	€ 0,90	€ 0,90	€ 0,90	€ 0,90	€ 0,90
<b>Order-No.</b>	<b>L</b>	1061	1201	1127	1187	1189	1205	1193	1195	1197	1199
<b>Price</b>		€ 0,90	€ 0,90	€ 0,90	€ 0,90	€ 0,90	€ 0,90	€ 0,90	€ 0,90	€ 0,90	€ 0,90
<b>Order-No.</b>	<b>A</b>	968	1038	1001	1031	1032	1040	1034	1035	1036	1037
<b>Price</b>		€ 1,80	€ 1,80	€ 1,80	€ 1,80	€ 1,80	€ 1,80	€ 1,80	€ 1,80	€ 1,80	€ 1,80

		%	/	"	
	Mat.				
<b>Order-No.</b>	<b>L</b>	1202	1206	1234	1190
<b>Price</b>		€ 0,90	€ 0,90	€ 0,90	€ 0,90
<b>Order-No.</b>	<b>L</b>	1203	1207	1235	1191
<b>Price</b>		€ 0,90	€ 0,90	€ 0,90	€ 0,90
<b>Order-No.</b>	<b>A</b>	1039	1041	1055	1033
<b>Price</b>		€ 1,80	€ 1,80	€ 1,80	€ 1,80

## 09 Series

Distance of observation 3 m

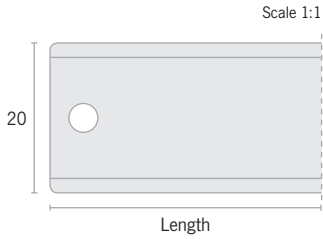

### Sp Slide-in profile

Material		Quantity	Article
Chlorid free plastic <b>K</b> / Aluminium, anodised <b>A</b>		5 pieces	0002
Length	Number of symbols*	Mat.	Mat.
72 mm	6	<b>Order-No.</b> <b>K</b> 2008 <b>Price</b> € 2,50	<b>Order-No.</b> <b>A</b> 1993 <b>Price</b> € 3,75
90 mm	8	<b>Order-No.</b> <b>K</b> 2009 <b>Price</b> € 2,75	<b>Order-No.</b> <b>A</b> 1994 <b>Price</b> € 4,00
108 mm	10	<b>Order-No.</b> <b>K</b> 2010 <b>Price</b> € 3,00	<b>Order-No.</b> <b>A</b> 1995 <b>Price</b> € 4,25
126 mm	12	<b>Order-No.</b> <b>K</b> 2011 <b>Price</b> € 3,25	<b>Order-No.</b> <b>A</b> 1996 <b>Price</b> € 4,50
144 mm	14	<b>Order-No.</b> <b>K</b> 2012 <b>Price</b> € 3,50	<b>Order-No.</b> <b>A</b> 1997 <b>Price</b> € 4,75
162 mm	16	<b>Order-No.</b> <b>K</b> 2013 <b>Price</b> € 3,75	<b>Order-No.</b> <b>A</b> 1998 <b>Price</b> € 5,00
180 mm	18	<b>Order-No.</b> <b>K</b> 2014 <b>Price</b> € 4,00	<b>Order-No.</b> <b>A</b> 1999 <b>Price</b> € 5,25
198 mm	20	<b>Order-No.</b> <b>K</b> 2015 <b>Price</b> € 4,25	<b>Order-No.</b> <b>A</b> 2000 <b>Price</b> € 5,50
216 mm	22	<b>Order-No.</b> <b>K</b> 2016 <b>Price</b> € 4,50	<b>Order-No.</b> <b>A</b> 2001 <b>Price</b> € 5,75
234 mm	24	<b>Order-No.</b> <b>K</b> 2017 <b>Price</b> € 4,75	<b>Order-No.</b> <b>A</b> 2002 <b>Price</b> € 6,00
252 mm	26	<b>Order-No.</b> <b>K</b> 2018 <b>Price</b> € 5,00	<b>Order-No.</b> <b>A</b> 2003 <b>Price</b> € 6,25
270 mm	28	<b>Order-No.</b> <b>K</b> 2019 <b>Price</b> € 5,25	<b>Order-No.</b> <b>A</b> 2004 <b>Price</b> € 6,50
288 mm	30	<b>Order-No.</b> <b>K</b> 2020 <b>Price</b> € 5,75	<b>Order-No.</b> <b>A</b> 2005 <b>Price</b> € 7,00
306 mm	32	<b>Order-No.</b> <b>K</b> 2021 <b>Price</b> € 6,25	<b>Order-No.</b> <b>A</b> 2006 <b>Price</b> € 7,50
324 mm	34	<b>Order-No.</b> <b>K</b> 2022 <b>Price</b> € 6,75	<b>Order-No.</b> <b>A</b> 2007 <b>Price</b> € 8,00

\*The number of symbols takes into account that there are always two additional outer elements.



### Gs GHS pictograms

Material		Quantity	Article		
Luxotherm® <b>L</b> / Aluminium, anodised <b>A</b>		10 pieces	0003		
<b>Mat.</b>	<b>GHS 01</b>	<b>GHS 02</b>	<b>GHS 03</b>	<b>GHS 04</b>	<b>GHS 05</b>
<b>Order-No.</b> <b>L</b>	1246	1247	1248	1249	1250
<b>Price</b>	€ 1,45	€ 1,45	€ 1,45	€ 1,45	€ 1,45
<b>Order-No.</b> <b>A</b>	1237	1238	1239	1240	1241
<b>Price</b>	€ 2,90	€ 2,90	€ 2,90	€ 2,90	€ 2,90
<b>Mat.</b>	<b>GHS 06</b>	<b>GHS 07</b>	<b>GHS 08</b>	<b>GHS 09</b>	
<b>Order-No.</b> <b>L</b>	1251	1252	1253	1254	
<b>Price</b>	€ 1,45	€ 1,45	€ 1,45	€ 1,45	
<b>Order-No.</b> <b>A</b>	1242	1243	1244	1245	
<b>Price</b>	€ 2,90	€ 2,90	€ 2,90	€ 2,90	

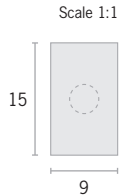

## Oe Outer elements

Material	Quantity	Article
Luxotherm® L   L Aluminium, anodised A	15 pieces	0001

DIN 2403		No Colour	Oxygen	Water	Steam	Air
Design	Mat.	Neutral	RAL5005	RAL6032	RAL3001	RAL7004
		Group 0	Group 1	Group 2	Group 3	
	<b>Order-No.</b> L	<b>41694</b>	-	-	-	-
	<b>Price</b>	€ 1,10	-	-	-	-
without hole	<b>Order-No.</b> L	<b>2110</b>	<b>2094</b>	<b>2096</b>	<b>2098</b>	<b>2100</b>
	<b>Price</b>	€ 1,10	€ 1,10	€ 1,10	€ 1,10	€ 1,10
	<b>Order-No.</b> A	<b>2090</b>	<b>2074</b>	<b>2076</b>	<b>2078</b>	<b>2080</b>
	<b>Price</b>	€ 2,20	€ 2,20	€ 2,20	€ 2,20	€ 2,20
with hole	<b>Order-No.</b> L	<b>41695</b>	-	-	-	-
	<b>Price</b>	€ 1,10	-	-	-	-
	<b>Order-No.</b> L	<b>2109</b>	<b>2093</b>	<b>2095</b>	<b>2097</b>	<b>2099</b>
	<b>Price</b>	€ 1,10	€ 1,10	€ 1,10	€ 1,10	€ 1,10
	<b>Order-No.</b> A	<b>2089</b>	<b>2073</b>	<b>2075</b>	<b>2077</b>	<b>2079</b>
	<b>Price</b>	€ 2,20	€ 2,20	€ 2,20	€ 2,20	€ 2,20

		Gases	Acids	Alkalis	Liquids & fixed materials	Additional Colour
Ausführung	Mat.	RAL1003	RAL2010	RAL4008	RAL8002	Black
		Group 4/5	Group 6	Group 7	Group 8/9	Add on
Nicht gelocht	<b>Bestellnr.</b> L	<b>2102</b>	<b>2104</b>	<b>2106</b>	<b>2108</b>	<b>2112</b>
	<b>Preis</b>	€ 1,10	€ 1,10	€ 1,10	€ 1,10	€ 1,10
	<b>Bestellnr.</b> A	<b>2082</b>	<b>2084</b>	<b>2086</b>	<b>2088</b>	<b>2092</b>
	<b>Preis</b>	€ 2,20	€ 2,20	€ 2,20	€ 2,20	€ 2,20
Gelocht	<b>Bestellnr.</b> L	<b>2101</b>	<b>2103</b>	<b>2105</b>	<b>2107</b>	<b>2111</b>
	<b>Preis</b>	€ 1,10	€ 1,10	€ 1,10	€ 1,10	€ 1,10
	<b>Bestellnr.</b> A	<b>2081</b>	<b>2083</b>	<b>2085</b>	<b>2087</b>	<b>2091</b>
	<b>Preis</b>	€ 2,20	€ 2,20	€ 2,20	€ 2,20	€ 2,20

NEN 3050		No Colour	Steam	Fire Fighting	Gases and Liquid Gases	Alkalis
Design	Mat.	No Colour	RAL9006	RAL3000	RAL1004	RAL4001
without hole	<b>Order-No.</b> L	<b>41694</b>	-	-	-	-
	<b>Price</b>	€ 1,10	-	-	-	-
	<b>Order-No.</b> L	<b>2110</b>	<b>2144</b>	<b>2134</b>	<b>2136</b>	<b>2132</b>
	<b>Price</b>	€ 1,10	€ 1,10	€ 1,10	€ 1,10	€ 1,10
	<b>Order-No.</b> A	<b>2090</b>	<b>2126</b>	<b>2116</b>	<b>2118</b>	<b>2114</b>
	<b>Price</b>	€ 2,20	€ 2,20	€ 2,20	€ 2,20	€ 2,20
with hole	<b>Order-No.</b> L	<b>41695</b>	-	-	-	-
	<b>Price</b>	€ 1,10	-	-	-	-
	<b>Order-No.</b> L	<b>2109</b>	<b>2143</b>	<b>2133</b>	<b>2135</b>	<b>2131</b>
	<b>Price</b>	€ 1,10	€ 1,10	€ 1,10	€ 1,10	€ 1,10
	<b>Order-No.</b> A	<b>2089</b>	<b>2125</b>	<b>2115</b>	<b>2117</b>	<b>2113</b>
	<b>Price</b>	€ 2,20	€ 2,20	€ 2,20	€ 2,20	€ 2,20

		Air	Oils and flammable liquids	Acids	Water	Other Liquids
Design	Mat.	RAL5012	RAL8001	RAL2008	RAL6010	Black
without hole	<b>Order-No.</b> L	<b>2138</b>	<b>2140</b>	<b>2148</b>	<b>2146</b>	<b>2112</b>
	<b>Price</b>	€ 1,10	€ 1,10	€ 1,10	€ 1,10	€ 1,10
	<b>Order-No.</b> A	<b>2120</b>	<b>2122</b>	<b>2130</b>	<b>2128</b>	<b>2092</b>
	<b>Price</b>	€ 2,20	€ 2,20	€ 2,20	€ 2,20	€ 2,20
with hole	<b>Order-No.</b> L	<b>2137</b>	<b>2139</b>	<b>2147</b>	<b>2145</b>	<b>2111</b>
	<b>Price</b>	€ 1,10	€ 1,10	€ 1,10	€ 1,10	€ 1,10
	<b>Order-No.</b> A	<b>2119</b>	<b>2121</b>	<b>2129</b>	<b>2127</b>	<b>2091</b>
	<b>Price</b>	€ 2,20	€ 2,20	€ 2,20	€ 2,20	€ 2,20

## 09 Series

Distance of observation 3 m

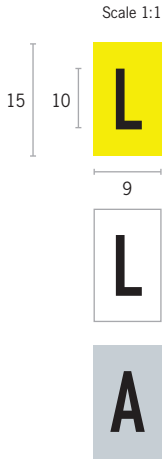

### Sy Symbols

Material (c54)		Quantity								Article	
Luxotherm® L (Yellow/Black)   L (White/Black) / Aluminium, anodised A (Silver/Black)		15 pieces								0003	
Mat.		A	a	B	b	C	c	D	d	E	e
Order-No.	L	1351	1417	1355	1421	1357	1423	1359	1425	1361	1427
Price	L	€ 1,10	€ 1,10	€ 1,10	€ 1,10	€ 1,10	€ 1,10	€ 1,10	€ 1,10	€ 1,10	€ 1,10
Order-No.	L	1352	1418	1356	1422	1358	1424	1360	1426	1362	1428
Price	L	€ 1,10	€ 1,10	€ 1,10	€ 1,10	€ 1,10	€ 1,10	€ 1,10	€ 1,10	€ 1,10	€ 1,10
Order-No.	A	1258	1291	1260	1293	1261	1294	1262	1295	1263	1296
Price	A	€ 2,20	€ 2,20	€ 2,20	€ 2,20	€ 2,20	€ 2,20	€ 2,20	€ 2,20	€ 2,20	€ 2,20
Mat.		F	f	G	g	H	h	I	i	J	j
Order-No.	L	1363	1429	1365	1431	1367	1433	1369	1435	1371	1437
Price	L	€ 1,10	€ 1,10	€ 1,10	€ 1,10	€ 1,10	€ 1,10	€ 1,10	€ 1,10	€ 1,10	€ 1,10
Order-No.	L	1364	1430	1366	1432	1368	1434	1370	1436	1372	1438
Price	L	€ 1,10	€ 1,10	€ 1,10	€ 1,10	€ 1,10	€ 1,10	€ 1,10	€ 1,10	€ 1,10	€ 1,10
Order-No.	A	1264	1297	1265	1298	1266	1299	1267	1300	1268	1301
Price	A	€ 2,20	€ 2,20	€ 2,20	€ 2,20	€ 2,20	€ 2,20	€ 2,20	€ 2,20	€ 2,20	€ 2,20
Mat.		K	k	L	l	M	m	N	n	O	o
Order-No.	L	1373	1439	1375	1441	1377	1443	1379	1445	1381	1447
Price	L	€ 1,10	€ 1,10	€ 1,10	€ 1,10	€ 1,10	€ 1,10	€ 1,10	€ 1,10	€ 1,10	€ 1,10
Order-No.	L	1374	1440	1376	1442	1378	1444	1380	1446	1382	1448
Price	L	€ 1,10	€ 1,10	€ 1,10	€ 1,10	€ 1,10	€ 1,10	€ 1,10	€ 1,10	€ 1,10	€ 1,10
Order-No.	A	1269	1302	1270	1303	1271	1304	1272	1305	1273	1306
Price	A	€ 2,20	€ 2,20	€ 2,20	€ 2,20	€ 2,20	€ 2,20	€ 2,20	€ 2,20	€ 2,20	€ 2,20
Mat.		P	p	Q	q	R	r	S	s	T	t
Order-No.	L	1385	1451	1387	1453	1389	1455	1391	1457	1393	1459
Price	L	€ 1,10	€ 1,10	€ 1,10	€ 1,10	€ 1,10	€ 1,10	€ 1,10	€ 1,10	€ 1,10	€ 1,10
Order-No.	L	1386	1452	1388	1454	1390	1456	1392	1458	1394	1460
Price	L	€ 1,10	€ 1,10	€ 1,10	€ 1,10	€ 1,10	€ 1,10	€ 1,10	€ 1,10	€ 1,10	€ 1,10
Order-No.	A	1275	1308	1276	1309	1277	1310	1278	1311	1279	1312
Price	A	€ 2,20	€ 2,20	€ 2,20	€ 2,20	€ 2,20	€ 2,20	€ 2,20	€ 2,20	€ 2,20	€ 2,20
Mat.		U	u	V	v	W	w	X	x	Y	y
Order-No.	L	1395	1461	1399	1465	1401	1467	1403	1469	1405	1471
Price	L	€ 1,10	€ 1,10	€ 1,10	€ 1,10	€ 1,10	€ 1,10	€ 1,10	€ 1,10	€ 1,10	€ 1,10
Order-No.	L	1396	1462	1400	1466	1402	1468	1404	1470	1406	1472
Price	L	€ 1,10	€ 1,10	€ 1,10	€ 1,10	€ 1,10	€ 1,10	€ 1,10	€ 1,10	€ 1,10	€ 1,10
Order-No.	A	1280	1313	1282	1315	1283	1316	1284	1317	1285	1318
Price	A	€ 2,20	€ 2,20	€ 2,20	€ 2,20	€ 2,20	€ 2,20	€ 2,20	€ 2,20	€ 2,20	€ 2,20



		Z	z	0	1	2	3	4	5	6	7
	Mat.										
Order-No.	L	1407	1473	1503	1505	1507	1509	1511	1513	1515	1517
Price		€ 1,10	€ 1,10	€ 1,10	€ 1,10	€ 1,10	€ 1,10	€ 1,10	€ 1,10	€ 1,10	€ 1,10
Order-No.	L	1408	1474	1504	1506	1508	1221	1512	1514	1516	1518
Price		€ 1,10	€ 1,10	€ 1,10	€ 1,10	€ 1,10	€ 1,10	€ 1,10	€ 1,10	€ 1,10	€ 1,10
Order-No.	A	1286	1319	1334	1335	1336	1048	1338	1339	1340	1341
Price		€ 2,20	€ 2,20	€ 2,20	€ 2,20	€ 2,20	€ 2,20	€ 2,20	€ 2,20	€ 2,20	€ 2,20

		8	9	2	2	3	3	4	4	!	:
	Mat.										
Order-No.	L	1519	1521	1409	1497	1411	1499	1413	1501	1345	1347
Price		€ 1,10	€ 1,10	€ 1,10	€ 1,10	€ 1,10	€ 1,10	€ 1,10	€ 1,10	€ 1,10	€ 1,10
Order-No.	L	1520	1522	1410	1498	1412	1500	1414	1502	1346	1348
Price		€ 1,10	€ 1,10	€ 1,10	€ 1,10	€ 1,10	€ 1,10	€ 1,10	€ 1,10	€ 1,10	€ 1,10
Order-No.	A	1342	1343	1287	1331	1288	1332	1289	1333	1255	1256
Price		€ 2,20	€ 2,20	€ 2,20	€ 2,20	€ 2,20	€ 2,20	€ 2,20	€ 2,20	€ 2,20	€ 2,20

		=	+	(	)	,	.	-	▶	▲	±
	Mat.										
Order-No.	L	1349	1489	1415	1475	1477	1493	1481	1483	1485	1487
Price		€ 1,10	€ 1,10	€ 1,10	€ 1,10	€ 1,10	€ 1,10	€ 1,10	€ 1,10	€ 1,10	€ 1,10
Order-No.	L	1350	1490	1416	1476	1478	1494	1482	1484	1486	1488
Price		€ 1,10	€ 1,10	€ 1,10	€ 1,10	€ 1,10	€ 1,10	€ 1,10	€ 1,10	€ 1,10	€ 1,10
Order-No.	A	1257	1327	1290	1320	1321	1329	1323	1324	1325	1326
Price		€ 2,20	€ 2,20	€ 2,20	€ 2,20	€ 2,20	€ 2,20	€ 2,20	€ 2,20	€ 2,20	€ 2,20

		%	/	"	
	Mat.				
Order-No.	L	1491	1495	1523	1479
Price		€ 1,10	€ 1,10	€ 1,10	€ 1,10
Order-No.	L	1492	1496	1524	1480
Price		€ 1,10	€ 1,10	€ 1,10	€ 1,10
Order-No.	A	1328	1330	1344	1322
Price		€ 2,20	€ 2,20	€ 2,20	€ 2,20

## 18 Series

Distance of observation 9 m

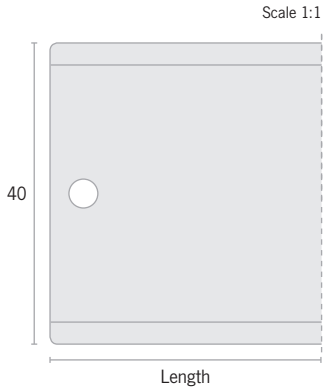

### Sp Slide-in profile







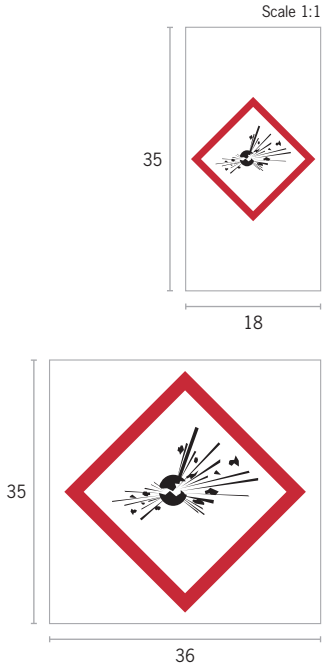

Material		Quantity	Article
Chlorid free plastic <b>K</b> / Aluminium, anodised <b>A</b>		5 pieces	0002
Length	Number of Symbols <sup>*</sup>	Mat.	Mat.
72 mm	2 / 3 <sup>**</sup>	<b>Order-No.</b> <b>K</b> <b>6782</b>	<b>Order-No.</b> <b>A</b> <b>6778</b>
		Price € 2,95	Price € 4,40
90 mm	3 / 4 <sup>**</sup>	<b>Order-No.</b> <b>K</b> <b>6783</b>	<b>Order-No.</b> <b>A</b> <b>6779</b>
		Price € 3,25	Price € 4,70
108 mm	4 / 5 <sup>**</sup>	<b>Order-No.</b> <b>K</b> <b>6784</b>	<b>Order-No.</b> <b>A</b> <b>6780</b>
		Price € 3,55	Price € 5,00
126 mm	5 / 6 <sup>**</sup>	<b>Order-No.</b> <b>K</b> <b>6785</b>	<b>Order-No.</b> <b>A</b> <b>6781</b>
		Price € 3,85	Price € 5,30
144 mm	6 / 7 <sup>**</sup>	<b>Order-No.</b> <b>K</b> <b>2036</b>	<b>Order-No.</b> <b>A</b> <b>2023</b>
		Price € 4,15	Price € 5,60
162 mm	7 / 8 <sup>**</sup>	<b>Order-No.</b> <b>K</b> <b>2037</b>	<b>Order-No.</b> <b>A</b> <b>2024</b>
		Price € 4,45	Price € 5,90
180 mm	8 / 9 <sup>**</sup>	<b>Order-No.</b> <b>K</b> <b>2038</b>	<b>Order-No.</b> <b>A</b> <b>2025</b>
		Price € 4,75	Price € 6,20
198 mm	9 / 10 <sup>**</sup>	<b>Order-No.</b> <b>K</b> <b>2039</b>	<b>Order-No.</b> <b>A</b> <b>2026</b>
		Price € 5,05	Price € 6,50
216 mm	10 / 11 <sup>**</sup>	<b>Order-No.</b> <b>K</b> <b>2040</b>	<b>Order-No.</b> <b>A</b> <b>2027</b>
		Price € 5,35	Price € 6,80
234 mm	11 / 12 <sup>**</sup>	<b>Order-No.</b> <b>K</b> <b>2041</b>	<b>Order-No.</b> <b>A</b> <b>2028</b>
		Price € 5,65	Price € 7,10
252 mm	12 / 13 <sup>**</sup>	<b>Order-No.</b> <b>K</b> <b>2042</b>	<b>Order-No.</b> <b>A</b> <b>2029</b>
		Price € 5,95	Price € 7,40
270 mm	13 / 14 <sup>**</sup>	<b>Order-No.</b> <b>K</b> <b>2043</b>	<b>Order-No.</b> <b>A</b> <b>2030</b>
		Price € 6,25	Price € 7,70
288 mm	14 / 15 <sup>**</sup>	<b>Order-No.</b> <b>K</b> <b>2044</b>	<b>Order-No.</b> <b>A</b> <b>2031</b>
		Price € 6,55	Price € 8,00
306 mm	15 / 16 <sup>**</sup>	<b>Order-No.</b> <b>K</b> <b>2045</b>	<b>Order-No.</b> <b>A</b> <b>2032</b>
		Price € 6,85	Price € 8,30
324 mm	16 / 17 <sup>**</sup>	<b>Order-No.</b> <b>K</b> <b>2046</b>	<b>Order-No.</b> <b>A</b> <b>2033</b>
		Price € 7,45	Price € 8,90
342 mm	17 / 18 <sup>**</sup>	<b>Order-No.</b> <b>K</b> <b>2047</b>	<b>Order-No.</b> <b>A</b> <b>2034</b>
		Price € 8,05	Price € 9,50
360 mm	18 / 19 <sup>**</sup>	<b>Order-No.</b> <b>K</b> <b>2048</b>	<b>Order-No.</b> <b>A</b> <b>2035</b>
		Price € 8,65	Price € 10,10

<sup>\*</sup>The number of symbols takes into account that there are always two additional outer elements.

<sup>\*\*</sup>With half outer elements

**Gs** GHS pictograms



Material		Luxotherm® L / Aluminium, anodised A								Quantity	Article
										10 pieces	0003
											
		GHS 01		GHS 02		GHS 03		GHS 04		GHS 05	
Mat.		18 mm	36 mm	18 mm	36 mm	18 mm	36 mm	18 mm	36 mm	18 mm	36 mm
Order-No.	L	1624	33305	1625	33306	1626	33307	1627	33308	1628	33309
Price		€ 2,35	€ 4,15	€ 2,35	€ 4,15	€ 2,35	€ 4,15	€ 2,35	€ 4,15	€ 2,35	€ 4,15
Order-No.	A	1525	33296	1526	33297	1527	33298	1528	33299	1529	33300
Price		€ 4,70	€ 8,30	€ 4,70	€ 8,30	€ 4,70	€ 8,30	€ 4,70	€ 8,30	€ 4,70	€ 8,30
											
		GHS 06		GHS 07		GHS 08		GHS 09			
Mat.		18 mm	36 mm	18 mm	36 mm	18 mm	36 mm	18 mm	36 mm		
Order-No.	L	1629	33310	1630	33311	1631	33312	1632	33313		
Price		€ 2,35	€ 4,15	€ 2,35	€ 4,15	€ 2,35	€ 4,15	€ 2,35	€ 4,15		
Order-No.	A	1530	33301	1531	33302	1532	33303	1533	33304		
Price		€ 4,70	€ 8,30	€ 4,70	€ 8,30	€ 4,70	€ 8,30	€ 4,70	€ 8,30		

## 18 Series

Distance of observation 9 m

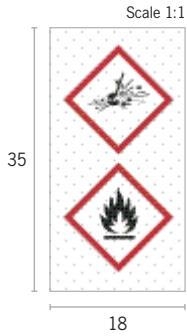

### Gs GHS double pictograms

Material	Quantity						Article
Luxotherm® L / Aluminium, anodised A	10 pieces						0003
	GHS 01/02	GHS 01/05	GHS 01/06	GHS 01/07	GHS 01/08	GHS 01/09	
Mat.							
Order-No. L	36548	36549	36550	36551	36552	36553	
Price	€ 2,35	€ 2,35	€ 2,35	€ 2,35	€ 2,35	€ 2,35	
Order-No. A	36523	36524	36525	36526	36527	36528	
Price	€ 4,70	€ 4,70	€ 4,70	€ 4,70	€ 4,70	€ 4,70	
	GHS 02/05	GHS 02/06	GHS 02/07	GHS 02/08	GHS 02/09		
Mat.							
Order-No. L	36554	36555	36556	36557	36558		
Price	€ 2,35	€ 2,35	€ 2,35	€ 2,35	€ 2,35		
Order-No. A	36529	36530	36531	36532	36533		
Price	€ 4,70	€ 4,70	€ 4,70	€ 4,70	€ 4,70		
	GHS 03/05	GHS 03/06	GHS 03/07	GHS 03/08	GHS 03/09		
Mat.							
Order-No. L	36559	36560	36561	36562	36563		
Price	€ 2,35	€ 2,35	€ 2,35	€ 2,35	€ 2,35		
Order-No. A	36534	36535	36536	36537	36538		
Price	€ 4,70	€ 4,70	€ 4,70	€ 4,70	€ 4,70		
	GHS 05/06	GHS 05/07	GHS 05/08	GHS 05/09			
Mat.							
Order-No. L	36564	36565	36566	36567			
Price	€ 2,35	€ 2,35	€ 2,35	€ 2,35			
Order-No. A	36539	36540	36541	36542			
Price	€ 4,70	€ 4,70	€ 4,70	€ 4,70			
	GHS 06/08	GHS 06/09	GHS 07/08	GHS 07/09	GHS 08/09		
Mat.							
Order-No. L	36568	36569	36570	36571	36572		
Price	€ 2,35	€ 2,35	€ 2,35	€ 2,35	€ 2,35		
Order-No. A	36543	36544	36545	36546	36547		
Price	€ 4,70	€ 4,70	€ 4,70	€ 4,70	€ 4,70		

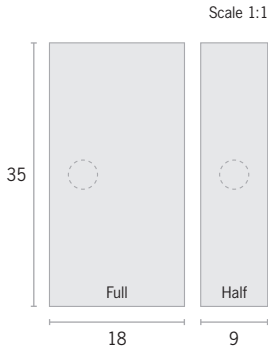

## Oe Outer Elements

Material	Quantity	Article
Luxotherm® L   L Aluminium, anodised A (Silber/Schwarz)	10 pcs. (full) / 15 pcs. (half)	0001

### DIN 2403

Design	Mat.	No colour		Oxygen RAL5005		Water RAL6032		Steam RAL3001		Air RAL7004	
		Neutral	Group 0	Group 1	Group 2	Group 3					
without hole	Order-No. L	41696	41698	-	-	-	-	-	-	-	-
	Price	€ 1,90	€ 2,25	-	-	-	-	-	-	-	-
	Order-No. A	2186	2298	2170	2282	2172	2284	2174	2286	2176	2288
Price	€ 1,90	€ 2,25	€ 1,90	€ 2,25	€ 1,90	€ 2,25	€ 1,90	€ 2,25	€ 1,90	€ 2,25	
with hole	Order-No. L	2166	2278	2150	2262	2152	2264	2154	2266	2156	2268
	Price	€ 3,80	€ 4,50	€ 3,80	€ 4,50	€ 3,80	€ 4,50	€ 3,80	€ 4,50	€ 3,80	€ 4,50
	Order-No. A	41697	41699	-	-	-	-	-	-	-	-
Price	€ 1,90	€ 2,25	-	-	-	-	-	-	-	-	
with hole	Order-No. L	2185	2297	2169	2281	2171	2283	2173	2285	2175	2287
	Price	€ 1,90	€ 2,25	€ 1,90	€ 2,25	€ 1,90	€ 2,25	€ 1,90	€ 2,25	€ 1,90	€ 2,25
	Order-No. A	2165	2277	2149	2261	2151	2263	2153	2265	2155	2267
Price	€ 3,80	€ 4,50	€ 3,80	€ 4,50	€ 3,80	€ 4,50	€ 3,80	€ 4,50	€ 3,80	€ 4,50	

Design	Mat.	Gases RAL1003		Acids RAL2010		Alkalis RAL4008		Liquids and fixed materials RAL8002		Additional Colour Black	
		Group 4/5	Group 6	Group 7	Group 8/9	Add on					
without hole	Order-No. L	2178	2290	2180	2292	2182	2294	2184	2296	2188	2300
	Price	€ 1,90	€ 2,25	€ 1,90	€ 2,25	€ 1,90	€ 2,25	€ 1,90	€ 2,25	€ 1,90	€ 2,25
	Order-No. A	2158	2270	2160	2272	2162	2274	2164	2276	2168	2280
Price	€ 3,80	€ 4,50	€ 3,80	€ 4,50	€ 3,80	€ 4,50	€ 3,80	€ 4,50	€ 3,80	€ 4,50	
with hole	Order-No. L	2177	2289	2179	2291	2181	2293	2183	2295	2187	2299
	Price	€ 1,90	€ 2,25	€ 1,90	€ 2,25	€ 1,90	€ 2,25	€ 1,90	€ 2,25	€ 1,90	€ 2,25
	Order-No. A	2157	2269	2159	2271	2161	2273	2163	2275	2167	2279
Price	€ 3,80	€ 4,50	€ 3,80	€ 4,50	€ 3,80	€ 4,50	€ 3,80	€ 4,50	€ 3,80	€ 4,50	

### NEN 3050

Design	Mat.	No colour		Steam RAL9006		Fire fighting RAL3000		Gases and liquid gases RAL1004		Alkalis RAL4001	
		Order-No. L	41696	41698	-	-	-	-	-	-	-
Price	€ 1,90	€ 2,25	-	-	-	-	-	-	-	-	
without hole	Order-No. L	2186	2298	2220	2256	2210	2246	2212	2248	2208	2244
	Price	€ 1,90	€ 2,25	€ 1,90	€ 2,25	€ 1,90	€ 2,25	€ 1,90	€ 2,25	€ 1,90	€ 2,25
	Order-No. A	2166	2278	2202	2238	2192	2228	2194	2230	2190	2226
Price	€ 3,80	€ 4,50	€ 3,80	€ 4,50	€ 3,80	€ 4,50	€ 3,80	€ 4,50	€ 3,80	€ 4,50	
with hole	Order-No. L	41697	41699	-	-	-	-	-	-	-	-
	Price	€ 1,90	€ 2,25	-	-	-	-	-	-	-	-
	Order-No. L	2185	2297	2219	2255	2209	2245	2211	2247	2207	2243
Price	€ 1,90	€ 2,25	€ 1,90	€ 2,25	€ 1,90	€ 2,25	€ 1,90	€ 2,25	€ 1,90	€ 2,25	
Order-No. A	2165	2277	2201	2237	2191	2227	2193	2229	2189	2225	
Price	€ 3,80	€ 4,50	€ 3,80	€ 4,50	€ 3,80	€ 4,50	€ 3,80	€ 4,50	€ 3,80	€ 4,50	

Design	Mat.	Air RAL5012		Oils and flammable liquids RAL8001		Acids RAL2008		Water RAL6010		Other liquids Black	
		Order-No. L	2214	2250	2216	2252	2224	2260	2222	2258	2188
Price	€ 1,90	€ 2,25	€ 1,90	€ 2,25	€ 1,90	€ 2,25	€ 1,90	€ 2,25	€ 1,90	€ 2,25	
without hole	Order-No. A	2196	2232	2198	2234	2206	2242	2204	2240	2168	2280
	Price	€ 3,80	€ 4,50	€ 3,80	€ 4,50	€ 3,80	€ 4,50	€ 3,80	€ 4,50	€ 3,80	€ 4,50
	Order-No. L	2213	2249	2215	2251	2223	2259	2221	2257	2187	2299
Price	€ 1,90	€ 2,25	€ 1,90	€ 2,25	€ 1,90	€ 2,25	€ 1,90	€ 2,25	€ 1,90	€ 2,25	
with hole	Order-No. A	2195	2231	2197	2233	2205	2241	2203	2239	2167	2279
	Price	€ 3,80	€ 4,50	€ 3,80	€ 4,50	€ 3,80	€ 4,50	€ 3,80	€ 4,50	€ 3,80	€ 4,50

## 18 Series

Distance of observation 9 m

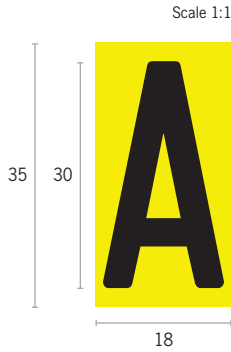

### Sy Symbols

		Material (colours)									Quantity	Article	
		Luxotherm® L (yellow/black)   L (white/black) / Aluminium, anodised A (silver/black)									10 pieces	0003	
		A	a	B	b	C	c	D	d	E	e		
	Mat.												
Order-No.	L	1639	1705	1643	1709	1645	1711	1647	1713	1649	1715		
Price		€ 1,90	€ 1,90	€ 1,90	€ 1,90	€ 1,90	€ 1,90	€ 1,90	€ 1,90	€ 1,90	€ 1,90		
Order-No.	L	1640	1706	1644	1710	1646	1712	1648	1714	1650	1716		
Price		€ 1,90	€ 1,90	€ 1,90	€ 1,90	€ 1,90	€ 1,90	€ 1,90	€ 1,90	€ 1,90	€ 1,90		
Order-No.	A	1537	1570	1539	1572	1540	1573	1541	1574	1542	1575		
Price		€ 3,80	€ 3,80	€ 3,80	€ 3,80	€ 3,80	€ 3,80	€ 3,80	€ 3,80	€ 3,80	€ 3,80		
		F	f	G	g	H	h	I	i	J	j		
	Mat.												
Order-No.	L	1651	1717	1653	1719	1655	1721	1657	1723	1659	1725		
Price		€ 1,90	€ 1,90	€ 1,90	€ 1,90	€ 1,90	€ 1,90	€ 1,90	€ 1,90	€ 1,90	€ 1,90		
Order-No.	L	1652	1718	1654	1720	1656	1722	1658	1724	1660	1726		
Price		€ 1,90	€ 1,90	€ 1,90	€ 1,90	€ 1,90	€ 1,90	€ 1,90	€ 1,90	€ 1,90	€ 1,90		
Order-No.	A	1543	1576	1544	1577	1545	1578	1546	1579	1547	1580		
Price		€ 3,80	€ 3,80	€ 3,80	€ 3,80	€ 3,80	€ 3,80	€ 3,80	€ 3,80	€ 3,80	€ 3,80		
		K	k	L	l	M	m	N	n	O	o		
	Mat.												
Order-No.	L	1661	1727	1663	1729	1665	1731	1667	1733	1669	1735		
Price		€ 1,90	€ 1,90	€ 1,90	€ 1,90	€ 1,90	€ 1,90	€ 1,90	€ 1,90	€ 1,90	€ 1,90		
Order-No.	L	1662	1728	1664	1730	1666	1732	1668	1734	1670	1736		
Price		€ 1,90	€ 1,90	€ 1,90	€ 1,90	€ 1,90	€ 1,90	€ 1,90	€ 1,90	€ 1,90	€ 1,90		
Order-No.	A	1548	1581	1549	1582	1550	1583	1551	1584	1552	1585		
Price		€ 3,80	€ 3,80	€ 3,80	€ 3,80	€ 3,80	€ 3,80	€ 3,80	€ 3,80	€ 3,80	€ 3,80		
		P	p	Q	q	R	r	S	s	T	t		
	Mat.												
Order-No.	L	1673	1739	1675	1741	1677	1743	1679	1745	1681	1747		
Price		€ 1,90	€ 1,90	€ 1,90	€ 1,90	€ 1,90	€ 1,90	€ 1,90	€ 1,90	€ 1,90	€ 1,90		
Order-No.	L	1674	1740	1676	1742	1678	1744	1680	1746	1682	1748		
Price		€ 1,90	€ 1,90	€ 1,90	€ 1,90	€ 1,90	€ 1,90	€ 1,90	€ 1,90	€ 1,90	€ 1,90		
Order-No.	A	1554	1587	1555	1588	1556	1589	1557	1590	1558	1591		
Price		€ 3,80	€ 3,80	€ 3,80	€ 3,80	€ 3,80	€ 3,80	€ 3,80	€ 3,80	€ 3,80	€ 3,80		
		U	u	V	v	W	w	X	x	Y	y		
	Mat.												
Order-No.	L	1683	1749	1687	1753	1689	1755	1691	1757	1693	1759		
Price		€ 1,90	€ 1,90	€ 1,90	€ 1,90	€ 1,90	€ 1,90	€ 1,90	€ 1,90	€ 1,90	€ 1,90		
Order-No.	L	1684	1750	1688	1754	1690	1756	1692	1758	1694	1760		
Price		€ 1,90	€ 1,90	€ 1,90	€ 1,90	€ 1,90	€ 1,90	€ 1,90	€ 1,90	€ 1,90	€ 1,90		
Order-No.	A	1559	1592	1561	1594	1562	1595	1563	1596	1564	1597		
Price		€ 3,80	€ 3,80	€ 3,80	€ 3,80	€ 3,80	€ 3,80	€ 3,80	€ 3,80	€ 3,80	€ 3,80		

		Z	z	0	1	2	3	4	5	6	7
	Mat.										
Order-No.	L	1695	1761	1791	1793	1795	1797	1799	1801	1803	1805
Price		€ 1,90	€ 1,90	€ 1,90	€ 1,90	€ 1,90	€ 1,90	€ 1,90	€ 1,90	€ 1,90	€ 1,90
Order-No.	L	1696	1762	1792	1794	1796	1798	1800	1802	1804	1806
Price		€ 1,90	€ 1,90	€ 1,90	€ 1,90	€ 1,90	€ 1,90	€ 1,90	€ 1,90	€ 1,90	€ 1,90
Order-No.	A	1565	1598	1613	1614	1615	1616	1617	1618	1619	1620
Price		€ 3,80	€ 3,80	€ 3,80	€ 3,80	€ 3,80	€ 3,80	€ 3,80	€ 3,80	€ 3,80	€ 3,80

		8	9	2	2	3	3	4	4	!	:
	Mat.										
Order-No.	L	1807	1809	1697	1785	1699	1787	1701	1789	1633	1635
Price		€ 1,90	€ 1,90	€ 1,90	€ 1,90	€ 1,90	€ 1,90	€ 1,90	€ 1,90	€ 1,90	€ 1,90
Order-No.	L	1808	1810	1698	1786	1700	1788	1702	1790	1634	1636
Price		€ 1,90	€ 1,90	€ 1,90	€ 1,90	€ 1,90	€ 1,90	€ 1,90	€ 1,90	€ 1,90	€ 1,90
Order-No.	A	1621	1622	1566	1610	1567	1611	1568	1612	1534	1535
Price		€ 3,80	€ 3,80	€ 3,80	€ 3,80	€ 3,80	€ 3,80	€ 3,80	€ 3,80	€ 3,80	€ 3,80

		=	+	(	)	,	.	-	▶	▲	◀
	Mat.										
Order-No.	L	1637	1777	1703	1763	1765	1781	1769	1771	1773	30303
Price		€ 1,90	€ 1,90	€ 1,90	€ 1,90	€ 1,90	€ 1,90	€ 1,90	€ 1,90	€ 1,90	€ 1,90
Order-No.	L	1638	1778	1704	1764	1766	1782	1770	1772	1774	30301
Price		€ 1,90	€ 1,90	€ 1,90	€ 1,90	€ 1,90	€ 1,90	€ 1,90	€ 1,90	€ 1,90	€ 1,90
Order-No.	A	1536	1606	1569	1599	1600	1608	1602	1603	1604	30299
Price		€ 3,80	€ 3,80	€ 3,80	€ 3,80	€ 3,80	€ 3,80	€ 3,80	€ 3,80	€ 3,80	€ 3,80

		◀▶	±	%	/	"	
	Mat.						
Order-No.	L	30304	1775	1779	1783	1811	1767
Price		€ 1,90	€ 1,90	€ 1,90	€ 1,90	€ 1,90	€ 1,90
Order-No.	L	30302	1776	1780	1784	1812	1768
Price		€ 1,90	€ 1,90	€ 1,90	€ 1,90	€ 1,90	€ 1,90
Order-No.	A	30300	1605	1607	1609	1623	1601
Price		€ 3,80	€ 3,80	€ 3,80	€ 3,80	€ 3,80	€ 3,80

# Printed and Engraved Signs

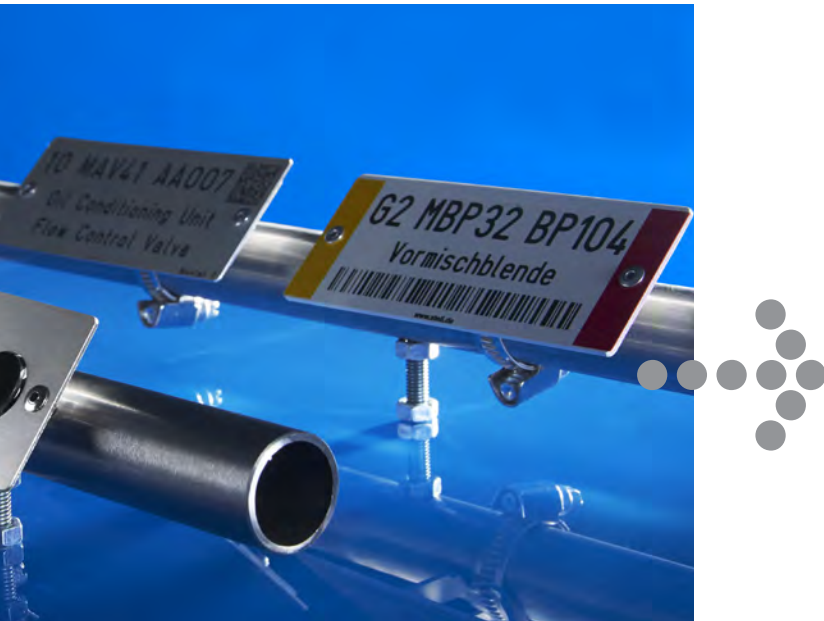

When we talk about signs, we are usually referring to engraved or printed signs for plant labelling which are manufactured at our location in Bocholt. Both versions are available in a variety of basic materials, the standard sizes are perfectly matched to our fastenings, and they can be provided with data components such as QR codes or RFID. The location's conditions serve as the determining factor in selecting the material and the production process.

## Printed Signs

Fast production even with large quantities.

Our machines can process a multitude of substrates with a wide variety of colour systems. These range from conventional solvent-based colours to multi-component colours and lacquers with extreme resistance to external influences through UV-hardening paints. Additionally, we offer a wide selection of printable materials, among them conventional poly-vinyl chloride, various metals, plastics and acrylates. This way, new and frequently used contents can be combined by making use of a multitude of implementation variants.

## Engraved Signs

The classic when it comes to price-performance ratio.

Simple and long-lasting labelling, even in temperature critical areas. Our in-house production allows us to offer cost-effective engraving and short-term delivery times. Through milling, machine engraving and laser engraving, we are able to cleanly and precisely label all plastic and metal signs. We offer about 80 different basic materials, surface textures and colour tones for you to choose from. When engraving and milling metals, the contrast in the material can also be significantly increased by the colouring of the milling groove.





### Standard sizes for printed and engraved signs

Below mentioned standard sizes match our fastening systems and tools. However, different sizes are available upon request.

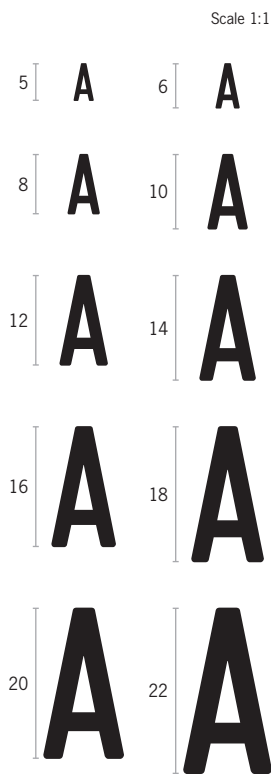
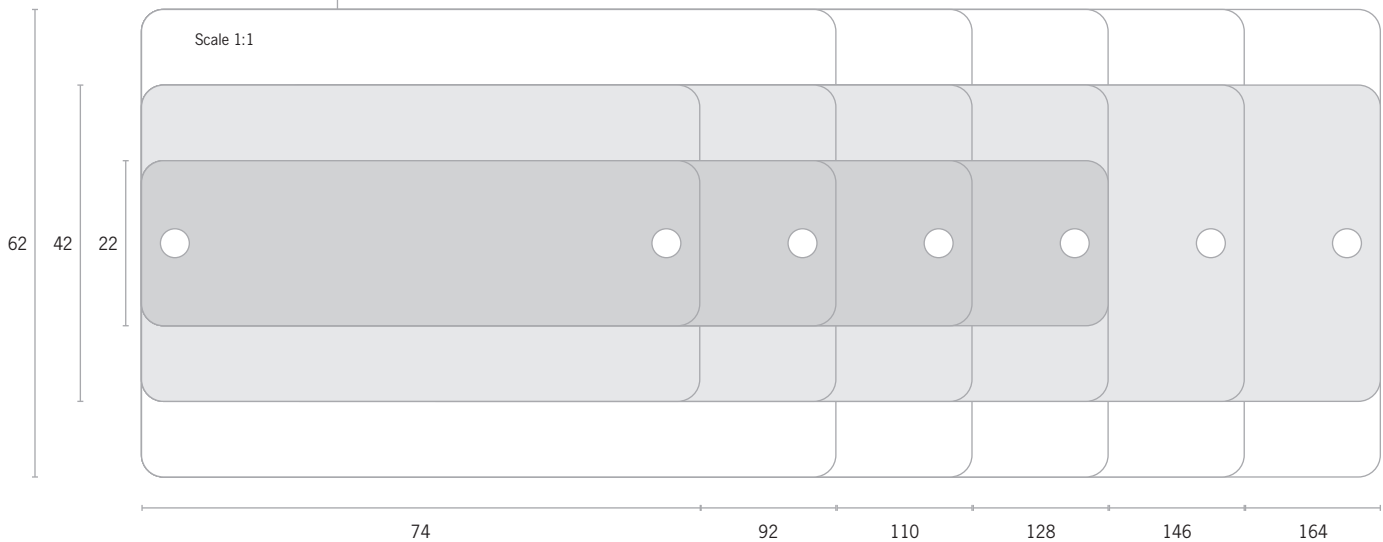

### Character count and distance of observation

Coding and text message represent the essence of a sign. The required length of the text depends on the desired, resp. the required height of the text and the resulting length of the sign.

Font height (mm)														
Distance of observation (m)														
		5	6	8	10	12	14	16	18	20	22			
		1,5	1,8	2,4	3	3,6	4,2	4,8	5,4	6	6,6			
Length (mm)	Height (mm)	Character count per line*												
74 mm	22	42	-	with hole	20	17	13	10	9	7	6	6	5	5
				without hole	24	20	15	12	10	8	7	7	6	6
92 mm	22	42	62	with hole	26	22	17	13	11	9	8	8	6	6
				without hole	30	25	19	15	12	10	9	9	7	7
110 mm	22	42	62	with hole	32	27	21	16	13	11	10	10	7	7
				without hole	36	30	23	18	14	12	11	11	8	8
128 mm	22	42	62	with hole	38	32	25	19	15	13	12	12	9	9
				without hole	42	35	27	21	16	14	13	13	10	10
146 mm	-	42	62	with hole	44	37	29	22	17	15	14	14	11	11
				without hole	48	40	31	23	18	16	15	15	12	12
164 mm	-	42	62	with hole	50	42	33	25	19	17	16	16	13	13
				without hole	54	45	35	27	20	18	17	17	14	14

\*Stated values are approximate values that can vary, depending on font. Standard font is DIN 1451.

## InSTELLigent Products – Signs with Barcode, Data Matrix and RFID



In addition to the optical information on our signs, electronically readable information is applied to them as a reference. Both our printed and engraved signs can contain an OCR font, a barcode or a Data Matrix as integral part of the print, resp. engraving. Additionally, the usage of RFID technology is an interesting option for the industries of our customers. These intelligent signs come in all sorts of shapes and represent interfaces for maintenance and servicing works of plants and plant parts and the automated identification on pipes, networks and components. We can offer you an extensive selection of signs and basic materials to create your individual interface, so please do not hesitate to get in contact with us.

### Data Matrix / OCR Code

The QR code, which is used often nowadays, can be especially well recognised by simple terminal devices, therefore offering an extensive range of applications. Even in rough environments, it is not very susceptible to contamination or scratching and it can still be read if up to 25% of it is damaged. The most important aspect for reliable readability is a suitable contrast between the background and the Data Matrix which mainly depends on the on-site lighting conditions. Would you like to know more about this application? Please get in contact with us!

### RFID

A step further with regard to automation and data exchange are RFID transponders. The RFID technology allows (process) information to be read, stored and overwritten in the transponder (at the installation location in the plant) without any physical contact. Any sign equipped with an RFID transponder can thus be uniquely identified without exception. Excellent adhesive quality and resistance also make our RFID signs suitable for use in harsher environments. And if you want to take this technology to the next level you should consider our new high-tech sign with integrated transponder – the R2D2 sign.

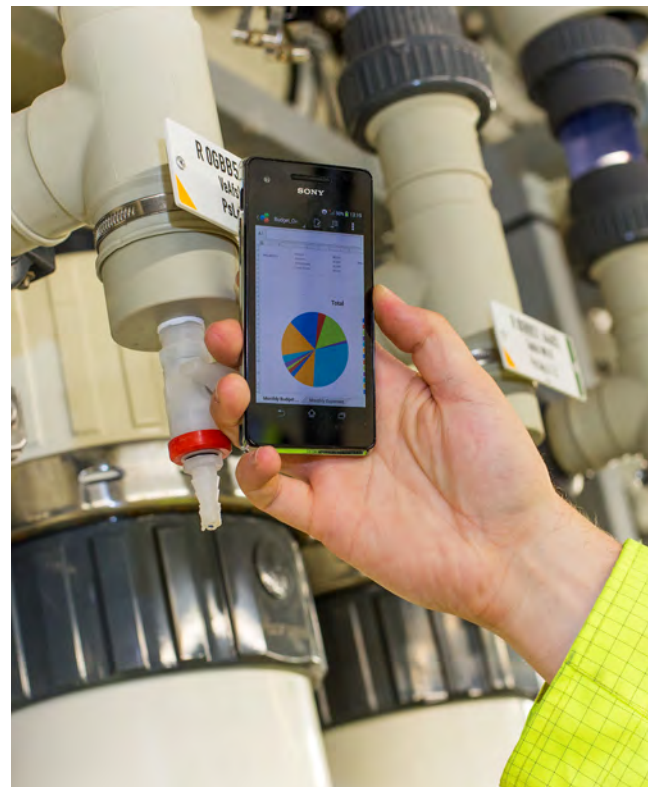

## R2D2 – Ran-in RFID Durable Datasign

Our patented R2D2 sign has been developed to offer digital interfaces for all plant areas even in harsh conditions. One solution for any kind of intended usage.

R2D2 consists of reinforced high-performance plastic in which an RFID transponder is permanently embedded. The basic material can be engraved or printed so it represents a perfect advancement of already existing labelling means. Thanks to the combination of implemented materials and production method and the fixed connection between the transponder and the sign, R2D2 is likely to be today's most resilient intelligent labelling solution. To get the most out of the R2D2 technology we've adjusted the production method so that all signs will undergo a complete automated check. This way we can guarantee that the visual and digital information of the sign is always identical, ensuring the most important aspect of safe automatization – 100% reliability.

### The benefits of R2D2 at a glance:

- Clear identification with a worldwide unique serial number
- 30 years of data security
- Standard frequency range of 13.56 MHz
- Guaranteed 100% match between text and data
- Temperature resistance from -40 °C to 150 °C
- Permanently embedded RFID transponder
- Excellent writing and reading qualities
- No shielding effects from metal (MoM)
- Very good resistance to UV radiation
- Good resistance to acid and chemicals
- Perfectly matched to our fastening systems



## Standard sizes of R2D2-signs

Scale 1:1

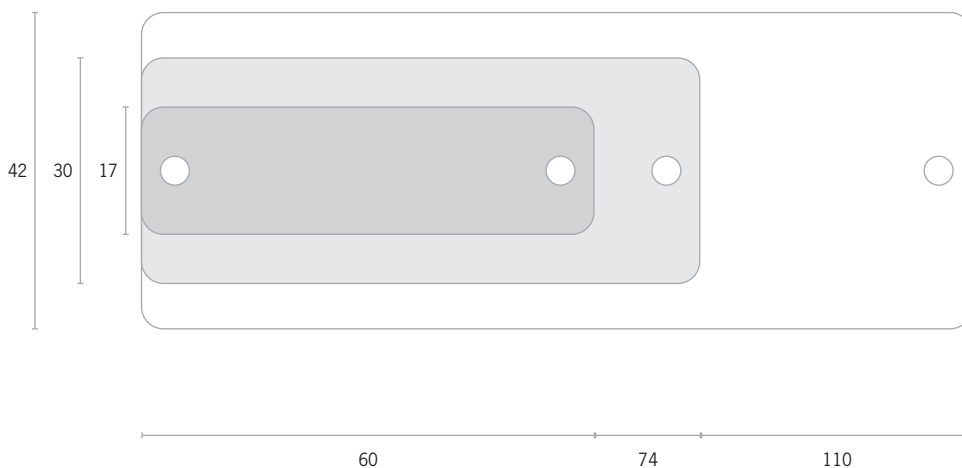

# Slide-In System



The slide-in system combines the advantages of the original Stell “Stecksystem” and the product range for engraved and printed signs. Comprised of a slide-in profile, an engraved or printed insert as well as insertable symbols, it offers you flexibility and increased information density.

The printed or engraved signs are inserted into a slide-in profile and contain customer-specific information on plant operation and the pipe sequence, or additional information on test circuits, pipe pressure or the addresses. In addition, the flow direction, GHS pictograms, colours, etc. are slid and riveted as standard elements in alignment with our standard sizes. The slide-in system is particularly suitable for our customers who would like to personally handle and change their labelling, but at the same time want to show a lot of concentrated on-site information.



**18 Series**

Slide-in profile = 144 mm, half outer elements

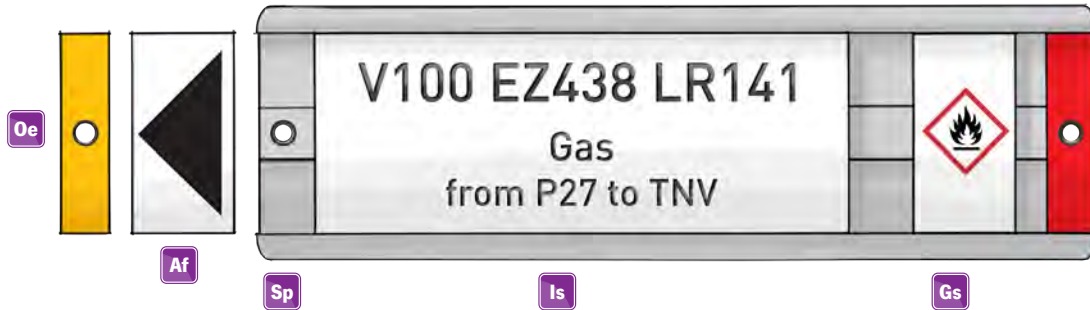

Sign bracket = 142 x 18 mm

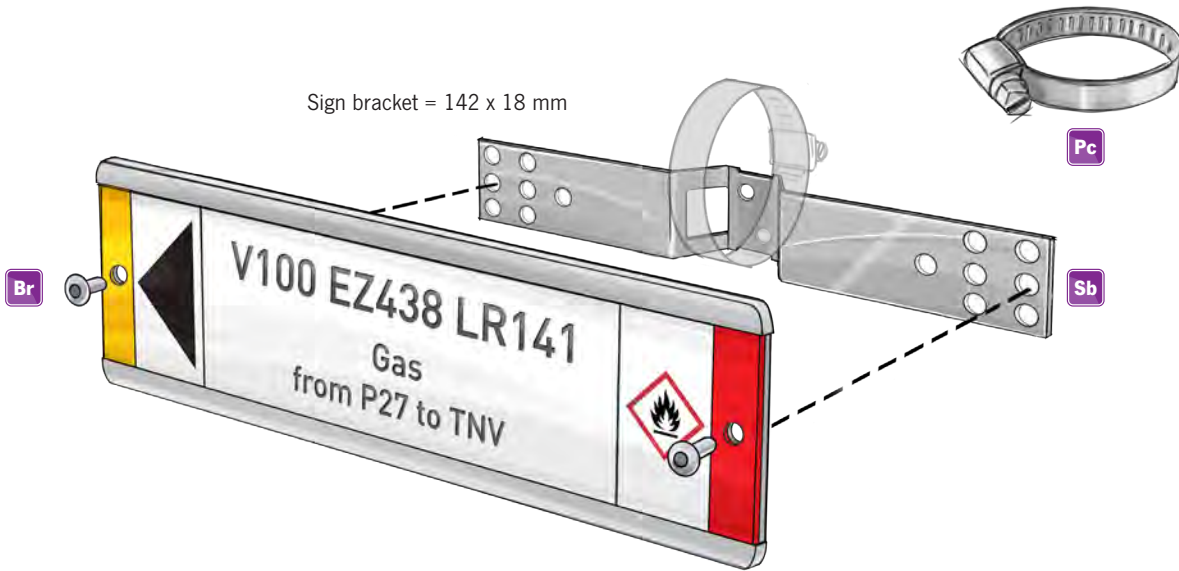

- |  |  |
|--|--|
| <b>Is</b> Inserts<br>page 40, 43, 47, 51           | <b>Af</b> Flow direction arrows<br>page 42, 45, 49, 53 |
| <b>Sp</b> Slide-in profiles<br>page 40, 43, 47, 51 | <b>Sb</b> Sign brackets<br>page Seite 65               |
| <b>Oe</b> Outer elements<br>page 41, 44, 48, 52    | <b>Pc</b> Pipe clamps<br>page Seite 66                 |
| <b>Gs</b> GHS pictograms<br>page 42, 45, 49, 53    | <b>Br</b> Blind rivets<br>page Seite 68                |

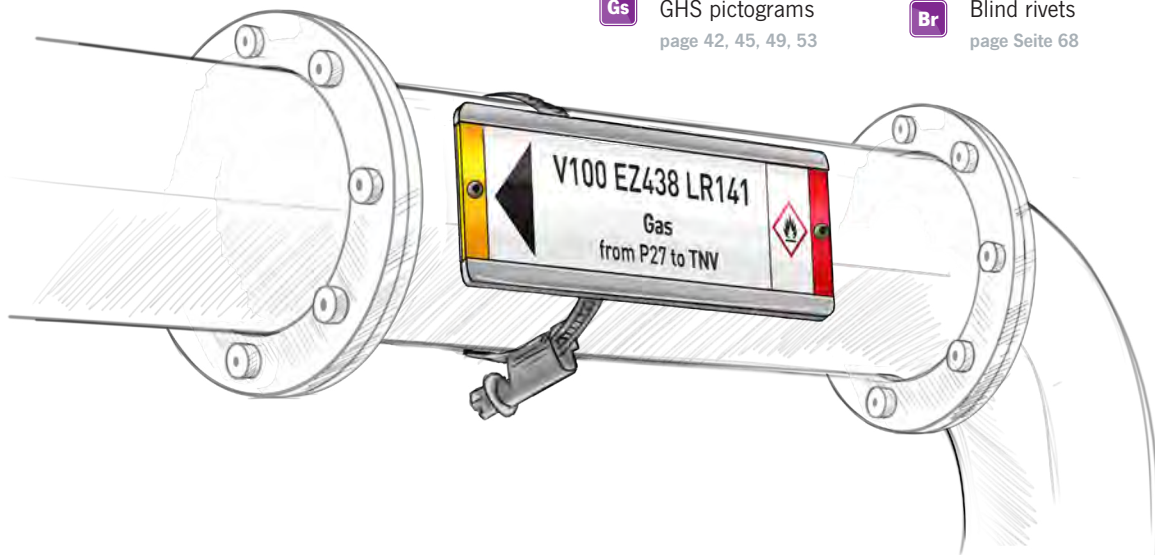

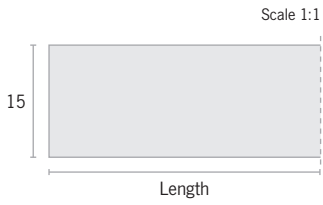

**Is** Inserts

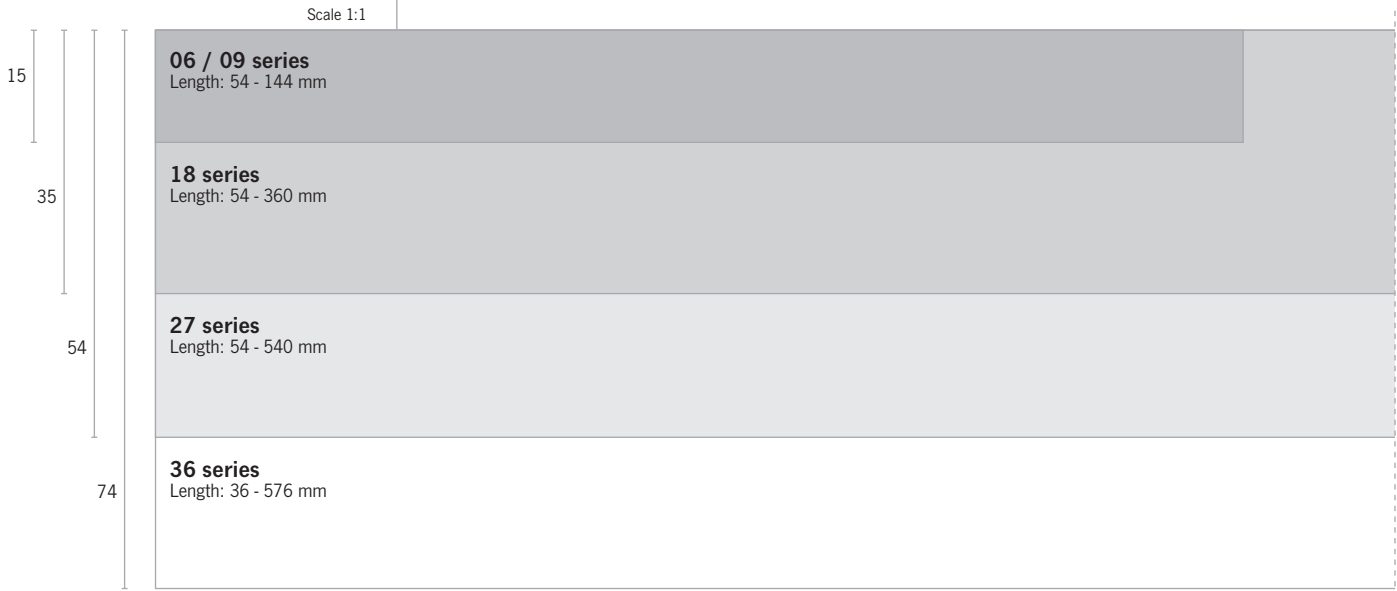

Scale 1:1

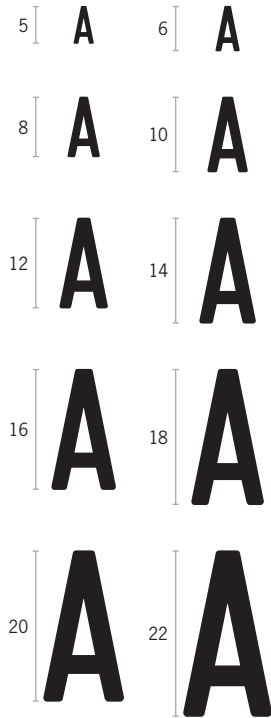

### Letter count and distance of observation

Coding and text message represent the essence of a sign. The required length of the text depends on the desired, resp. the required height of the text and the resulting length of the sign. The following overview shows the relevant proportions for engraved and printed signs.

Font height (mm)	5	6	8	10	12	14	16	18	20	22					
Distance of observation (m)	1,5	1,8	2,4	3	3,6	4,2	4,8	5,4	6	6,6					
Serie ▶	06/09	18	27	36											
Length of inserts	Height of inserts (mm)				Character count per line**										
36 mm	-	-	-	74	11	9	7	5	4	3	3	3	2	2	
54 mm	15	35	54	74	17	14	10	8	7	6	5	4	4	3	
72 mm	15	35	54	74	23	19	14	11	9	8	7	6	5	5	
81 mm	-	-	54	-	26	21	16	13	10	9	8	7	6	5	
90 mm	15	35	54	74	29	24	18	14	12	10	9	8	7	6	
99 mm	-	35	54	-	32	26	20	16	13	11	10	8	8	7	
108 mm	15	35	54	74	35	29	21	17	14	12	10	9	8	7	
117 mm	-	35	54	-	37	31	23	18	15	13	12	10	9	8	
126 mm	15	35	54	74	40	34	25	20	17	14	12	11	10	9	
135 mm	-	35	54	-	43	36	27	21	18	15	13	12	10	9	
144 mm	15	35	-	74	46	38	29	23	19	16	14	12	11	10	
153 mm	-	35	54	-	49	41	30	24	20	17	15	13	12	11	
162 mm	-	35	54	74	52	43	32	26	21	18	16	14	13	11	
171 mm	-	35	54	-	55	46	34	27	23	19	17	15	13	12	
180 mm	-	35	54	74	58	48	36	29	24	20	18	16	14	13	
189 mm	-	35	54	-	61	51	38	30	25	21	19	17	15	13	
198 mm	-	35	54	74	64	53	40	32	26	22	20	17	16	14	
207 mm	-	35	54	-	67	55	41	33	27	23	20	18	16	15	
216 mm	-	35	54	74	69	58	43	34	29	24	21	19	17	15	
225 mm	-	35	54	-	72	60	45	36	30	26	22	20	18	16	
234 mm	-	35	54	74	75	63	47	37	31	27	23	21	18	17	
243 mm	-	35	54	-	78	65	49	39	32	28	24	21	19	17	
252 mm	-	35	54	74	81	68	51	40	34	29	25	22	20	18	
261 mm	-	35	54	-	84	70	52	42	35	30	26	23	21	19	
270 mm	-	35	54	74	87	72	54	43	36	31	27	24	21	19	
279 mm	-	35	54	-	90	75	56	45	37	32	28	25	22	20	
288 mm	-	35	54	74	93	77	58	46	38	33	29	25	23	21	
297 mm	-	35	54	-	96	80	60	48	40	34	30	26	24	21	
306 mm	-	35	54	74	99	82	61	49	41	35	31	27	24	22	
315 mm	-	35	54	-	101	85	63	51	42	36	31	28	25	23	
324 mm	-	35	54	74	104	87	65	52	43	37	32	29	26	23	
333 mm	-	35	54	-	107	90	67	53	45	38	33	29	26	24	
342 mm	-	35	54	74	111	92	69	55	46	39	34	30	27	25	
351 mm	-	35	54	-	113	94	71	56	47	40	35	31	28	25	
360 mm	-	-	-	74	116	97	72	58	48	41	36	32	29	26	
369 mm	-	-	54	-	119	99	74	59	49	42	37	33	29	27	
378 mm	-	-	54	-	122	102	76	61	51	43	38	34	30	27	
396 mm	-	-	-	74	129	107	80	64	53	45	40	35	31	28	
405 mm	-	-	54	-	131	109	81	65	54	46	41	36	32	29	
414 mm	-	-	54	-	133	111	83	67	55	47	41	37	33	30	
432 mm	-	-	54	74	139	116	87	70	58	50	43	38	35	31	
441 mm	-	-	54	-	142	119	89	71	59	51	44	39	35	32	
450 mm	-	-	54	74	145	121	91	72	60	52	45	40	36	33	
459 mm	-	-	54	-	148	124	92	74	62	53	46	41	37	33	
468 mm	-	-	54	74	151	127	94	75	63	54	47	42	37	34	
477 mm	-	-	54	-	154	128	96	77	64	55	48	42	38	35	
486 mm	-	-	54	-	157	131	98	78	65	56	49	43	39	35	
504 mm	-	-	54	74	163	136	102	81	67	58	51	45	40	37	
513 mm	-	-	54	-	166	138	103	83	69	59	51	46	41	37	
540 mm	-	-	54	74	174	145	109	87	72	62	54	48	43	39	
576 mm	-	-	-	74	186	155	116	93	77	66	58	51	46	42	

\*Stated values are approximate values that can vary, depending on font. Standard font is DIN 1451.

Please note: The max. character count might vary due to the different shapes of the characters. As standard for calculation, the letter "G" had been set for the fonts listed on the right side.

## 06 / 09 Series

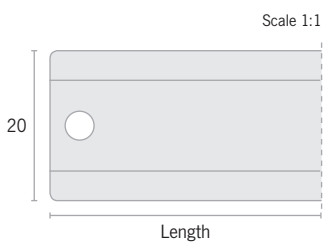
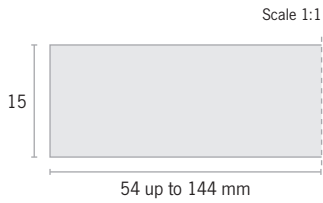

### Is Inserts

Standard sizes 54 up to 144 mm. Other sizes and prices on request.

### Sp Slide-in profile

Material		Quantity	Article		
Chlorid free plastic <b>K</b> / Aluminium, anodised <b>A</b>		5 pieces	0002		
Length	Length of insert*	Order-No.	Price	Mat.	Article
72 mm	54 mm	<b>K</b> 2008	€ 2,50	<b>A</b>	<b>1993</b> € 3,75
90 mm	72 mm	<b>K</b> 2009	€ 2,75	<b>A</b>	<b>1994</b> € 4,00
108 mm	90 mm	<b>K</b> 2010	€ 3,00	<b>A</b>	<b>1995</b> € 4,25
126 mm	108 mm	<b>K</b> 2011	€ 3,25	<b>A</b>	<b>1996</b> € 4,50
144 mm	126 mm	<b>K</b> 2012	€ 3,50	<b>A</b>	<b>1997</b> € 4,75
162 mm	144 mm	<b>K</b> 2013	€ 3,75	<b>A</b>	<b>1998</b> € 5,00

\*The number of symbols takes into account that there are always two additional outer elements.

**Fastening:** page 65



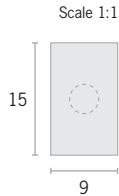

## Oe Outer elements

Material	Quantity	Article
Luxotherm® L   L Aluminium, anodised A	15 pieces	0001

DIN 2403		No Colour	Oxygen	Water	Steam	Air
Design	Mat.	Neutral	RAL5005	RAL6032	RAL3001	RAL7004
		Group 0	Group 1	Group 2	Group 3	
	<b>Order-No.</b> L	<b>41694</b>	-	-	-	-
	<b>Price</b>	€ 1,10	-	-	-	-
without hole	<b>Order-No.</b> L	<b>2110</b>	<b>2094</b>	<b>2096</b>	<b>2098</b>	<b>2100</b>
	<b>Price</b>	€ 1,10	€ 1,10	€ 1,10	€ 1,10	€ 1,10
	<b>Order-No.</b> A	<b>2090</b>	<b>2074</b>	<b>2076</b>	<b>2078</b>	<b>2080</b>
	<b>Price</b>	€ 2,20	€ 2,20	€ 2,20	€ 2,20	€ 2,20
with hole	<b>Order-No.</b> L	<b>41695</b>	-	-	-	-
	<b>Price</b>	€ 1,10	-	-	-	-
	<b>Order-No.</b> L	<b>2109</b>	<b>2093</b>	<b>2095</b>	<b>2097</b>	<b>2099</b>
	<b>Price</b>	€ 1,10	€ 1,10	€ 1,10	€ 1,10	€ 1,10
	<b>Order-No.</b> A	<b>2089</b>	<b>2073</b>	<b>2075</b>	<b>2077</b>	<b>2079</b>
	<b>Price</b>	€ 2,20	€ 2,20	€ 2,20	€ 2,20	€ 2,20

		Gases	Acids	Alkalis	Liquids & fixed materials	Additional Colour
Ausführung	Mat.	RAL1003	RAL2010	RAL4008	RAL8002	Black
		Group 4/5	Group 6	Group 7	Group 8/9	Add on
Nicht gelocht	<b>Bestellnr.</b> L	<b>2102</b>	<b>2104</b>	<b>2106</b>	<b>2108</b>	<b>2112</b>
	<b>Preis</b>	€ 1,10	€ 1,10	€ 1,10	€ 1,10	€ 1,10
	<b>Bestellnr.</b> A	<b>2082</b>	<b>2084</b>	<b>2086</b>	<b>2088</b>	<b>2092</b>
	<b>Preis</b>	€ 2,20	€ 2,20	€ 2,20	€ 2,20	€ 2,20
Gelocht	<b>Bestellnr.</b> L	<b>2101</b>	<b>2103</b>	<b>2105</b>	<b>2107</b>	<b>2111</b>
	<b>Preis</b>	€ 1,10	€ 1,10	€ 1,10	€ 1,10	€ 1,10
	<b>Bestellnr.</b> A	<b>2081</b>	<b>2083</b>	<b>2085</b>	<b>2087</b>	<b>2091</b>
	<b>Preis</b>	€ 2,20	€ 2,20	€ 2,20	€ 2,20	€ 2,20

NEN 3050		No Colour	Steam	Fire Fighting	Gases and Liquid Gases	Alkalis
Design	Mat.		RAL9006	RAL3000	RAL1004	RAL4001
without hole	<b>Order-No.</b> L	<b>41694</b>	-	-	-	-
	<b>Price</b>	€ 1,10	-	-	-	-
	<b>Order-No.</b> L	<b>2110</b>	<b>2144</b>	<b>2134</b>	<b>2136</b>	<b>2132</b>
	<b>Price</b>	€ 1,10	€ 1,10	€ 1,10	€ 1,10	€ 1,10
	<b>Order-No.</b> A	<b>2090</b>	<b>2126</b>	<b>2116</b>	<b>2118</b>	<b>2114</b>
	<b>Price</b>	€ 2,20	€ 2,20	€ 2,20	€ 2,20	€ 2,20
with hole	<b>Order-No.</b> L	<b>41695</b>	-	-	-	-
	<b>Price</b>	€ 1,10	-	-	-	-
	<b>Order-No.</b> L	<b>2109</b>	<b>2143</b>	<b>2133</b>	<b>2135</b>	<b>2131</b>
	<b>Price</b>	€ 1,10	€ 1,10	€ 1,10	€ 1,10	€ 1,10
	<b>Order-No.</b> A	<b>2089</b>	<b>2125</b>	<b>2115</b>	<b>2117</b>	<b>2113</b>
	<b>Price</b>	€ 2,20	€ 2,20	€ 2,20	€ 2,20	€ 2,20

		Air	Oils and flammable liquids	Acids	Water	Other Liquids
Design	Mat.	RAL5012	RAL8001	RAL2008	RAL6010	Black
without hole	<b>Order-No.</b> L	<b>2138</b>	<b>2140</b>	<b>2148</b>	<b>2146</b>	<b>2112</b>
	<b>Price</b>	€ 1,10	€ 1,10	€ 1,10	€ 1,10	€ 1,10
	<b>Order-No.</b> A	<b>2120</b>	<b>2122</b>	<b>2130</b>	<b>2128</b>	<b>2092</b>
	<b>Price</b>	€ 2,20	€ 2,20	€ 2,20	€ 2,20	€ 2,20
with hole	<b>Order-No.</b> L	<b>2137</b>	<b>2139</b>	<b>2147</b>	<b>2145</b>	<b>2111</b>
	<b>Price</b>	€ 1,10	€ 1,10	€ 1,10	€ 1,10	€ 1,10
	<b>Order-No.</b> A	<b>2119</b>	<b>2121</b>	<b>2129</b>	<b>2127</b>	<b>2091</b>
	<b>Price</b>	€ 2,20	€ 2,20	€ 2,20	€ 2,20	€ 2,20

06 / 09 Series



**Gs** GHS pictograms

Material	Quantity	Article
Luxotherm® L / Aluminium, anodised A	10 pieces	0003

	GHS 01	GHS 02	GHS 03	GHS 04	GHS 05
<i>Mat.</i>					
<b>Order-No.</b> L	1246	1247	1248	1249	1250
<b>Price</b>	€ 1,45	€ 1,45	€ 1,45	€ 1,45	€ 1,45
<b>Order-No.</b> A	1237	1238	1239	1240	1241
<b>Price</b>	€ 2,90	€ 2,90	€ 2,90	€ 2,90	€ 2,90
<i>Mat.</i>					
<b>Order-No.</b> L	1251	1252	1253	1254	
<b>Price</b>	€ 1,45	€ 1,45	€ 1,45	€ 1,45	
<b>Order-No.</b> A	1242	1243	1244	1245	
<b>Price</b>	€ 2,90	€ 2,90	€ 2,90	€ 2,90	

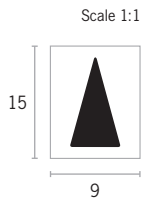

**Af** Flow direction arrows

Material	Quantity	Article
Luxotherm® L / Aluminium, anodised A	15 pieces	0003

<i>Mat.</i>		
<b>Order-No.</b> L	1484	1486
<b>Price</b>	€ 1,10	€ 1,10
<b>Order-No.</b> A	1324	1325
<b>Price</b>	€ 2,20	€ 2,20

## 18 Series

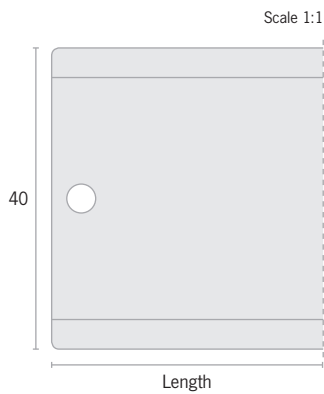
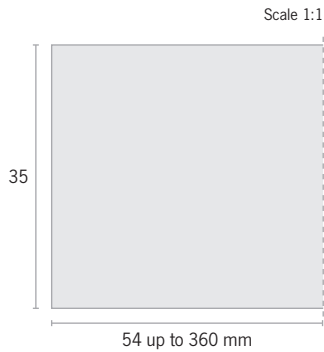

### Is Inserts

Standard sizes 54 up to 360 mm. Other sizes and prices on request.

### Sp Slide-in profiles

Material		Quantity	Article				
Chlorid free plastic <b>K</b> / Aluminium, anodised <b>A</b>		5 pieces	0002				
Length	Length of inserts*	Order-No.	Price	Mat.	Order-No.	Price	Mat.
72 mm	- / 54** mm	<b>K 6782</b>	€ 2,95	<b>A 6778</b>	<b>K 6778</b>	€ 4,40	
90 mm	54 / 72** mm	<b>K 6783</b>	€ 3,25	<b>A 6779</b>	<b>K 6779</b>	€ 4,70	
108 mm	72 / 90** mm	<b>K 6784</b>	€ 3,55	<b>A 6780</b>	<b>K 6780</b>	€ 5,00	
126 mm	90 / 108** mm	<b>K 6785</b>	€ 3,85	<b>A 6781</b>	<b>K 6781</b>	€ 5,30	
144 mm	108 / 126** mm	<b>K 2036</b>	€ 4,15	<b>A 2023</b>	<b>K 2023</b>	€ 5,60	
162 mm	126 / 144** mm	<b>K 2037</b>	€ 4,45	<b>A 2024</b>	<b>K 2024</b>	€ 5,90	
180 mm	144 / 162** mm	<b>K 2038</b>	€ 4,75	<b>A 2025</b>	<b>K 2025</b>	€ 6,20	
198 mm	162 / 180** mm	<b>K 2039</b>	€ 5,05	<b>A 2026</b>	<b>K 2026</b>	€ 6,50	
216 mm	180 / 198** mm	<b>K 2040</b>	€ 5,35	<b>A 2027</b>	<b>K 2027</b>	€ 6,80	
234 mm	198 / 216** mm	<b>K 2041</b>	€ 5,65	<b>A 2028</b>	<b>K 2028</b>	€ 7,10	
252 mm	216 / 234** mm	<b>K 2042</b>	€ 5,95	<b>A 2029</b>	<b>K 2029</b>	€ 7,40	
270 mm	234 / 252** mm	<b>K 2043</b>	€ 6,25	<b>A 2030</b>	<b>K 2030</b>	€ 7,70	
288 mm	252 / 270** mm	<b>K 2044</b>	€ 6,55	<b>A 2031</b>	<b>K 2031</b>	€ 8,00	
306 mm	270 / 288** mm	<b>K 2045</b>	€ 6,85	<b>A 2032</b>	<b>K 2032</b>	€ 8,30	
324 mm	288 / 306** mm	<b>K 2046</b>	€ 7,45	<b>A 2033</b>	<b>K 2033</b>	€ 8,90	
342 mm	306 / 324** mm	<b>K 2047</b>	€ 8,05	<b>A 2034</b>	<b>K 2034</b>	€ 9,50	
360 mm	324 / 342** mm	<b>K 2048</b>	€ 8,65	<b>A 2035</b>	<b>K 2035</b>	€ 10,10	

\* The number of symbols takes into account that there are always two additional outer elements.  
 \*\* With half outer elements

**Fastening:** page 65

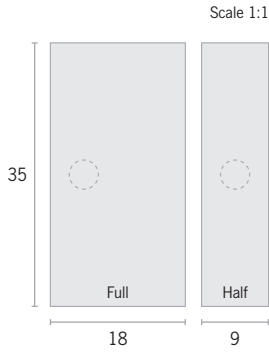

**Oe** Outer Elements

Material		Quantity		Article							
Luxotherm® L   L Aluminium, anodised A		10 pcs. (full)/15 pcs. (half)		0001							
<b>DIN 2403</b>		No colour		Oxygen	Water	Steam	Air				
				RAL5005	RAL6032	RAL3001	RAL7004				
<i>Design</i>	<i>Mat.</i>	Neutral		Group 0		Group 1		Group 2		Group 3	
	Order-No.	41696	41698	-	-	-	-	-	-	-	-
	Price	€ 1,90	€ 2,25	-	-	-	-	-	-	-	-
without hole	Order-No.	2186	2298	2170	2282	2172	2284	2174	2286	2176	2288
	Price	€ 1,90	€ 2,25	€ 1,90	€ 2,25	€ 1,90	€ 2,25	€ 1,90	€ 2,25	€ 1,90	€ 2,25
	Order-No.	2166	2278	2150	2262	2152	2264	2154	2266	2156	2268
	Price	€ 3,80	€ 4,50	€ 3,80	€ 4,50	€ 3,80	€ 4,50	€ 3,80	€ 4,50	€ 3,80	€ 4,50
with hole	Order-No.	41697	41699	-	-	-	-	-	-	-	-
	Price	€ 1,90	€ 2,25	-	-	-	-	-	-	-	-
	Order-No.	2185	2297	2169	2281	2171	2283	2173	2285	2175	2287
	Price	€ 1,90	€ 2,25	€ 1,90	€ 2,25	€ 1,90	€ 2,25	€ 1,90	€ 2,25	€ 1,90	€ 2,25
	Order-No.	2165	2277	2149	2261	2151	2263	2153	2265	2155	2267
	Price	€ 3,80	€ 4,50	€ 3,80	€ 4,50	€ 3,80	€ 4,50	€ 3,80	€ 4,50	€ 3,80	€ 4,50
		Gases		Acids		Alkalis		Liquids and fixed materials		Additional Colour	
		RAL1003		RAL2010		RAL4008		RAL8002		Black	
<i>Design</i>	<i>Mat.</i>	Group 4/5		Group 6		Group 7		Group 8/9		Add on	
without hole	Order-No.	2178	2290	2180	2292	2182	2294	2184	2296	2188	2300
	Price	€ 1,90	€ 2,25	€ 1,90	€ 2,25	€ 1,90	€ 2,25	€ 1,90	€ 2,25	€ 1,90	€ 2,25
	Order-No.	2158	2270	2160	2272	2162	2274	2164	2276	2168	2280
	Price	€ 3,80	€ 4,50	€ 3,80	€ 4,50	€ 3,80	€ 4,50	€ 3,80	€ 4,50	€ 3,80	€ 4,50
with hole	Order-No.	2177	2289	2179	2291	2181	2293	2183	2295	2187	2299
	Price	€ 1,90	€ 2,25	€ 1,90	€ 2,25	€ 1,90	€ 2,25	€ 1,90	€ 2,25	€ 1,90	€ 2,25
	Order-No.	2157	2269	2159	2271	2161	2273	2163	2275	2167	2279
	Price	€ 3,80	€ 4,50	€ 3,80	€ 4,50	€ 3,80	€ 4,50	€ 3,80	€ 4,50	€ 3,80	€ 4,50
<b>NEN 3050</b>		No colour		Steam	Fire fighting	Gases and liquid gases	Alkalis				
				RAL9006	RAL3000	RAL1004	RAL4001				
<i>Design</i>	<i>Mat.</i>	Neutral		Group 4		Group 5					
without hole	Order-No.	41696	41698	-	-	-	-				
	Price	€ 1,90	€ 2,25	-	-	-	-				
	Order-No.	2186	2298	2220	2256	2210	2246				
	Price	€ 1,90	€ 2,25	€ 1,90	€ 2,25	€ 1,90	€ 2,25				
	Order-No.	2166	2278	2202	2238	2192	2228				
	Price	€ 3,80	€ 4,50	€ 3,80	€ 4,50	€ 3,80	€ 4,50				
with hole	Order-No.	41697	41699	-	-	-	-				
	Price	€ 1,90	€ 2,25	-	-	-	-				
	Order-No.	2185	2297	2219	2255	2209	2245				
	Price	€ 1,90	€ 2,25	€ 1,90	€ 2,25	€ 1,90	€ 2,25				
	Order-No.	2165	2277	2201	2237	2191	2227				
	Price	€ 3,80	€ 4,50	€ 3,80	€ 4,50	€ 3,80	€ 4,50				
		Air		Oils and flammable liquids	Acids	Water	Other liquids				
		RAL5012		RAL8001	RAL2008	RAL6010	Black				
<i>Design</i>	<i>Mat.</i>	Group 1		Group 2		Group 3					
without hole	Order-No.	2214	2250	2216	2252	2224	2260				
	Price	€ 1,90	€ 2,25	€ 1,90	€ 2,25	€ 1,90	€ 2,25				
	Order-No.	2196	2232	2198	2234	2206	2242				
	Price	€ 3,80	€ 4,50	€ 3,80	€ 4,50	€ 3,80	€ 4,50				
with hole	Order-No.	2213	2249	2215	2251	2223	2259				
	Price	€ 1,90	€ 2,25	€ 1,90	€ 2,25	€ 1,90	€ 2,25				
	Order-No.	2195	2231	2197	2233	2205	2241				
	Price	€ 3,80	€ 4,50	€ 3,80	€ 4,50	€ 3,80	€ 4,50				

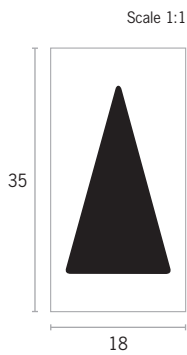
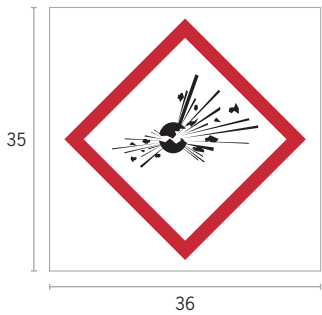
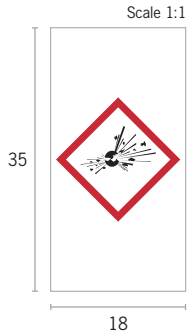

### Gs GHS pictograms

Material	Quantity	Article
Luxotherm® L / Aluminium, anodised A	10 pieces	0003

	GHS 01		GHS 02		GHS 03		GHS 04		GHS 05	
Mat.	18 mm	36 mm	18 mm	36 mm	18 mm	36 mm	18 mm	36 mm	18 mm	36 mm
Order-No. L	1624	33305	1625	33306	1626	33307	1627	33308	1628	33309
Price	€ 2,35	€ 4,15	€ 2,35	€ 4,15	€ 2,35	€ 4,15	€ 2,35	€ 4,15	€ 2,35	€ 4,15
Order-No. A	1525	33296	1526	33297	1527	33298	1528	33299	1529	33300
Price	€ 4,70	€ 8,30	€ 4,70	€ 8,30	€ 4,70	€ 8,30	€ 4,70	€ 8,30	€ 4,70	€ 8,30

	GHS 06		GHS 07		GHS 08		GHS 09	
Mat.	18 mm	36 mm	18 mm	36 mm	18 mm	36 mm	18 mm	36 mm
Order-No. L	1629	33310	1630	33311	1631	33312	1632	33313
Price	€ 2,35	€ 4,15	€ 2,35	€ 4,15	€ 2,35	€ 4,15	€ 2,35	€ 4,15
Order-No. A	1530	33301	1531	33302	1532	33303	1533	33304
Price	€ 4,70	€ 8,30	€ 4,70	€ 8,30	€ 4,70	€ 8,30	€ 4,70	€ 8,30

### Fa Flow direction arrows

Material	Quantity	Article
Luxotherm® L / Aluminium, anodised A	10 pieces	0003

	Right		Up		Down	
Mat.	18 mm	36 mm	18 mm	36 mm	18 mm	36 mm
Order-No. L	1772	1774	30301	30302	30301	30302
Price	€ 1,90	€ 1,90	€ 1,90	€ 1,90	€ 1,90	€ 1,90
Order-No. A	1603	1604	30299	30300	30299	30300
Price	€ 3,80	€ 3,80	€ 3,80	€ 3,80	€ 3,80	€ 3,80

## 18 Series

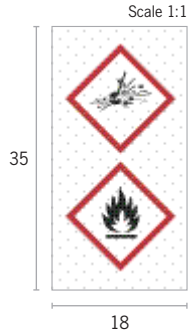

### Gs GHS double pictograms

Material							Quantity	Article
Luxotherm® L / Aluminium, anodised A							10 pieces	0003
	GHS 01/02	GHS 01/05	GHS 01/06	GHS 01/07	GHS 01/08	GHS 01/09		
Mat.								
Order-No. L	36548	36549	36550	36551	36552	36553		
Price	€ 2,35	€ 2,35	€ 2,35	€ 2,35	€ 2,35	€ 2,35		
Order-No. A	36523	36524	36525	36526	36527	36528		
Price	€ 4,70	€ 4,70	€ 4,70	€ 4,70	€ 4,70	€ 4,70		
	GHS 02/05	GHS 02/06	GHS 02/07	GHS 02/08	GHS 02/09			
Mat.								
Order-No. L	36554	36555	36556	36557	36558			
Price	€ 2,35	€ 2,35	€ 2,35	€ 2,35	€ 2,35			
Order-No. A	36529	36530	36531	36532	36533			
Price	€ 4,70	€ 4,70	€ 4,70	€ 4,70	€ 4,70			
	GHS 03/05	GHS 03/06	GHS 03/07	GHS 03/08	GHS 03/09			
Mat.								
Order-No. L	36559	36560	36561	36562	36563			
Price	€ 2,35	€ 2,35	€ 2,35	€ 2,35	€ 2,35			
Order-No. A	36534	36535	36536	36537	36538			
Price	€ 4,70	€ 4,70	€ 4,70	€ 4,70	€ 4,70			
	GHS 05/06	GHS 05/07	GHS 05/08	GHS 05/09				
Mat.								
Order-No. L	36564	36565	36566	36567				
Price	€ 2,35	€ 2,35	€ 2,35	€ 2,35				
Order-No. A	36539	36540	36541	36542				
Price	€ 4,70	€ 4,70	€ 4,70	€ 4,70				
	GHS 06/08	GHS 06/09	GHS 07/08	GHS 07/09	GHS 08/09			
Mat.								
Order-No. L	36568	36569	36570	36571	36572			
Price	€ 2,35	€ 2,35	€ 2,35	€ 2,35	€ 2,35			
Order-No. A	36543	36544	36545	36546	36547			
Price	€ 4,70	€ 4,70	€ 4,70	€ 4,70	€ 4,70			

## 27 Series

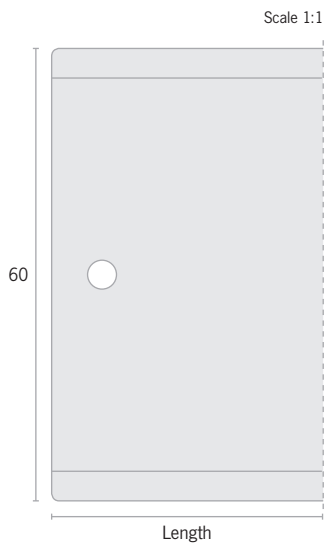
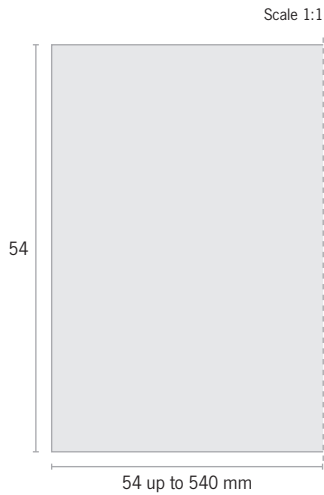

### Is Inserts

Standard sizes 54 up to 540 mm. Other sizes and prices on request.

### Sp Slide-in profiles

Material	Quantity	Article
Chlorid free plastic <b>K</b> / Aluminium, anodised <b>A</b>	5 pieces	0008

Length	Length of inserts*	Mat.	Mat.
108 mm	54 / 81** mm	<b>Order-No.</b> <b>K</b> 6812 Price € 4,05	<b>Order-No.</b> <b>A</b> 6794 Price € 6,05
126 mm	72 / 99** mm	<b>Order-No.</b> <b>K</b> 22066 Price € 4,40	<b>Order-No.</b> <b>A</b> 22059 Price € 6,40
144 mm	90 / 117** mm	<b>Order-No.</b> <b>K</b> 22067 Price € 4,75	<b>Order-No.</b> <b>A</b> 22060 Price € 6,75
162 mm	108 / 135** mm	<b>Order-No.</b> <b>K</b> 544 Price € 5,10	<b>Order-No.</b> <b>A</b> 536 Price € 7,10
180 mm	126 / 153** mm	<b>Order-No.</b> <b>K</b> 22068 Price € 5,45	<b>Order-No.</b> <b>A</b> 22061 Price € 7,45
198 mm	144 / 171** mm	<b>Order-No.</b> <b>K</b> 22069 Price € 5,80	<b>Order-No.</b> <b>A</b> 22062 Price € 7,80
216 mm	162 / 189** mm	<b>Order-No.</b> <b>K</b> 545 Price € 6,15	<b>Order-No.</b> <b>A</b> 537 Price € 8,15
234 mm	180 / 207** mm	<b>Order-No.</b> <b>K</b> 22070 Price € 6,50	<b>Order-No.</b> <b>A</b> 22063 Price € 8,50
252 mm	198 / 225** mm	<b>Order-No.</b> <b>K</b> 22071 Price € 6,85	<b>Order-No.</b> <b>A</b> 22064 Price € 8,85
270 mm	216 / 243** mm	<b>Order-No.</b> <b>K</b> 546 Price € 7,20	<b>Order-No.</b> <b>A</b> 538 Price € 9,20
288 mm	234 / 261** mm	<b>Order-No.</b> <b>K</b> 6813 Price € 7,55	<b>Order-No.</b> <b>A</b> 6795 Price € 9,75
306 mm	252 / 279** mm	<b>Order-No.</b> <b>K</b> 6814 Price € 7,90	<b>Order-No.</b> <b>A</b> 6796 Price € 10,30
324 mm	270 / 297** mm	<b>Order-No.</b> <b>K</b> 547 Price € 8,25	<b>Order-No.</b> <b>A</b> 539 Price € 10,85
342 mm	288 / 315** mm	<b>Order-No.</b> <b>K</b> 6815 Price € 8,60	<b>Order-No.</b> <b>A</b> 6797 Price € 11,40
360 mm	306 / 333** mm	<b>Order-No.</b> <b>K</b> 6816 Price € 8,95	<b>Order-No.</b> <b>A</b> 6798 Price € 11,95
378 mm	324 / 351** mm	<b>Order-No.</b> <b>K</b> 548 Price € 9,30	<b>Order-No.</b> <b>A</b> 540 Price € 12,50
396 mm	342 / 369** mm	<b>Order-No.</b> <b>K</b> 6817 Price € 9,65	<b>Order-No.</b> <b>A</b> 6799 Price € 13,05
432 mm	378 / 405** mm	<b>Order-No.</b> <b>K</b> 549 Price € 10,00	<b>Order-No.</b> <b>A</b> 541 Price € 13,60
468 mm	414 / 441** mm	<b>Order-No.</b> <b>K</b> 6818 Price € 10,35	<b>Order-No.</b> <b>A</b> 6800 Price € 14,15
486 mm	432 / 459** mm	<b>Order-No.</b> <b>K</b> 550 Price € 11,05	<b>Order-No.</b> <b>A</b> 542 Price € 15,25
504 mm	450 / 477** mm	<b>Order-No.</b> <b>K</b> 6819 Price € 11,75	<b>Order-No.</b> <b>A</b> 6801 Price € 16,35
540 mm	486 / 513** mm	<b>Order-No.</b> <b>K</b> 551 Price € 12,45	<b>Order-No.</b> <b>A</b> 543 Price € 17,45

\* The number of symbols takes into account that there are always two additional outer elements.  
\*\* With half outer elements

Scale 1:1

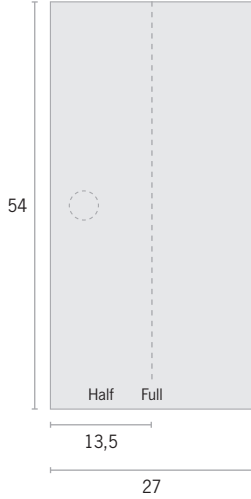

**Oe** Outer elements

Material	Quantity	Article
Luxotherm® L / Aluminium, anodised A	10 pieces	0007

		DIN 2403		No colour		Oxygen RAL5005		Water RAL6032		Steam RAL3001		Air RAL7004	
		Neutral		Group 0		Group 1		Group 2		Group 3			
Design	Mat.	Full	Half	Full	Half	Full	Half	Full	Half	Full	Half	Full	Half
without hole	Order-No. L	619	20921	603	20905	605	20907	607	20909	609	20911	609	20911
	Price	€ 2,40	€ 2,90	€ 2,40	€ 2,90	€ 2,40	€ 2,90	€ 2,40	€ 2,90	€ 2,40	€ 2,90	€ 2,40	€ 2,90
with hole	Order-No. A	599	20901	583	20885	585	20887	587	20889	589	20891	589	20891
	Price	€ 4,80	€ 5,80	€ 4,80	€ 5,80	€ 4,80	€ 5,80	€ 4,80	€ 5,80	€ 4,80	€ 5,80	€ 4,80	€ 5,80
without hole	Order-No. L	618	20920	602	20904	604	20906	606	20908	608	20910	608	20910
	Price	€ 2,40	€ 2,90	€ 2,40	€ 2,90	€ 2,40	€ 2,90	€ 2,40	€ 2,90	€ 2,40	€ 2,90	€ 2,40	€ 2,90
with hole	Order-No. A	598	20900	582	20884	584	20886	586	20888	588	20890	588	20890
	Price	€ 4,80	€ 5,80	€ 4,80	€ 5,80	€ 4,80	€ 5,80	€ 4,80	€ 5,80	€ 4,80	€ 5,80	€ 4,80	€ 5,80

		Gases RAL1003		Acids RAL2010		Alkalis RAL4008		Liquids and fixed materials RAL8002		Additional colour Black			
		Group 4/5		Group 6		Group 7		Group 8/9		Add on			
Design	Mat.	Full	Half	Full	Half	Full	Half	Full	Half	Full	Half	Full	Half
without hole	Order-No. L	611	20913	613	20915	615	20917	617	20919	621	20923	621	20923
	Price	€ 2,40	€ 2,90	€ 2,40	€ 2,90	€ 2,40	€ 2,90	€ 2,40	€ 2,90	€ 2,40	€ 2,90	€ 2,40	€ 2,90
with hole	Order-No. A	591	20893	593	20895	595	20897	597	20899	601	20903	601	20903
	Price	€ 4,80	€ 5,80	€ 4,80	€ 5,80	€ 4,80	€ 5,80	€ 4,80	€ 5,80	€ 4,80	€ 5,80	€ 4,80	€ 5,80
without hole	Order-No. L	610	20912	612	20914	614	20916	616	20918	620	20922	620	20922
	Price	€ 2,40	€ 2,90	€ 2,40	€ 2,90	€ 2,40	€ 2,90	€ 2,40	€ 2,90	€ 2,40	€ 2,90	€ 2,40	€ 2,90
with hole	Order-No. A	590	20892	592	20894	594	20896	596	20898	600	20902	600	20902
	Price	€ 4,80	€ 5,80	€ 4,80	€ 5,80	€ 4,80	€ 5,80	€ 4,80	€ 5,80	€ 4,80	€ 5,80	€ 4,80	€ 5,80

		No colour		Steam RAL9006		Fire fighting RAL3000		Gases and liquids gases RAL1004		Alkalis RAL4001			
Design	Mat.	Full	Half	Full	Half	Full	Half	Full	Half	Full	Half	Full	Half
without hole	Order-No. L	619	20921	653	20955	643	20945	645	20947	641	20943	641	20943
	Price	€ 2,40	€ 2,90	€ 2,40	€ 2,90	€ 2,40	€ 2,90	€ 2,40	€ 2,90	€ 2,40	€ 2,90	€ 2,40	€ 2,90
with hole	Order-No. A	599	20901	635	20937	625	20927	627	20929	623	20925	623	20925
	Price	€ 4,80	€ 5,80	€ 4,80	€ 5,80	€ 4,80	€ 5,80	€ 4,80	€ 5,80	€ 4,80	€ 5,80	€ 4,80	€ 5,80
without hole	Order-No. L	618	20920	652	20954	642	20944	644	20946	640	20942	640	20942
	Price	€ 2,40	€ 2,90	€ 2,40	€ 2,90	€ 2,40	€ 2,90	€ 2,40	€ 2,90	€ 2,40	€ 2,90	€ 2,40	€ 2,90
with hole	Order-No. A	598	20900	634	20936	624	20926	626	20928	622	20924	622	20924
	Price	€ 4,80	€ 5,80	€ 4,80	€ 5,80	€ 4,80	€ 5,80	€ 4,80	€ 5,80	€ 4,80	€ 5,80	€ 4,80	€ 5,80

		Air RAL5012		Oils and other flammable liquids RAL8001		Acids RAL2008		Water RAL6010		Other liquids Black			
Design	Mat.	Full	Half	Full	Half	Full	Half	Full	Half	Full	Half	Full	Half
without hole	Order-No. L	647	20949	649	20951	657	20959	655	20957	621	20923	621	20923
	Price	€ 2,40	€ 2,90	€ 2,40	€ 2,90	€ 2,40	€ 2,90	€ 2,40	€ 2,90	€ 2,40	€ 2,90	€ 2,40	€ 2,90
with hole	Order-No. A	629	20931	631	20933	639	20941	637	20939	601	20903	601	20903
	Price	€ 4,80	€ 5,80	€ 4,80	€ 5,80	€ 4,80	€ 5,80	€ 4,80	€ 5,80	€ 4,80	€ 5,80	€ 4,80	€ 5,80
without hole	Order-No. L	646	20948	648	20950	656	20958	654	20956	620	20922	620	20922
	Price	€ 2,40	€ 2,90	€ 2,40	€ 2,90	€ 2,40	€ 2,90	€ 2,40	€ 2,90	€ 2,40	€ 2,90	€ 2,40	€ 2,90
with hole	Order-No. A	628	20930	630	20932	638	20940	636	20938	600	20902	600	20902
	Price	€ 4,80	€ 5,80	€ 4,80	€ 5,80	€ 4,80	€ 5,80	€ 4,80	€ 5,80	€ 4,80	€ 5,80	€ 4,80	€ 5,80



## 27 Series

Scale 1:2

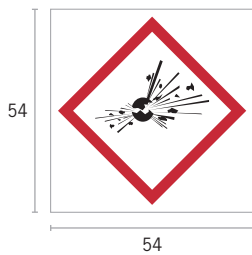
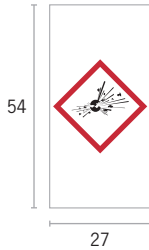

Scale 1:1

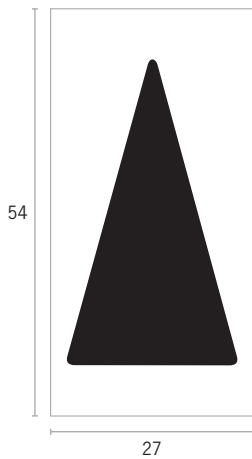

### Gs GHS pictograms

Material	Quantity	Article
Luxotherm® L / Aluminium, anodised A	10 pieces	0009

	GHS 01		GHS 02		GHS 03		GHS 04		GHS 05	
Mat.	27 mm	54 mm	27 mm	54 mm	27 mm	54 mm	27 mm	54 mm	27 mm	54 mm
Order-No.	463	33333	466	33334	469	33335	471	33336	474	33337
Price	€ 2,95	€ 5,25	€ 2,95	€ 5,25	€ 2,95	€ 5,25	€ 2,95	€ 5,25	€ 2,95	€ 5,25
Order-No.	438	33324	441	33325	444	33326	446	33327	449	33328
Price	€ 5,90	€ 9,90	€ 5,90	€ 9,90	€ 5,90	€ 9,90	€ 5,90	€ 9,90	€ 5,90	€ 9,90

	GHS 06		GHS 07		GHS 08		GHS 09	
Mat.	27 mm	54 mm	27 mm	54 mm	27 mm	54 mm	27 mm	54 mm
Order-No.	476	33341	478	33338	481	33339	483	33340
Price	€ 2,95	€ 5,25	€ 2,95	€ 5,25	€ 2,95	€ 5,25	€ 2,95	€ 5,25
Order-No.	451	33329	453	33330	456	33331	458	33332
Price	€ 5,90	€ 9,90	€ 5,90	€ 9,90	€ 5,90	€ 9,90	€ 5,90	€ 9,90

### Af Flow direction arrows

Material	Quantity	Article
Luxotherm® L / Aluminium, anodised A	10 pieces	0009

	484		485		30307		30308	
Mat.	27 mm	54 mm	27 mm	54 mm	27 mm	54 mm	27 mm	54 mm
Order-No.	484	485	30307	30308	459	460	30305	30306
Price	€ 2,40	€ 2,40	€ 4,80	€ 4,80	€ 4,80	€ 4,80	€ 4,80	€ 4,80

## 27 Series

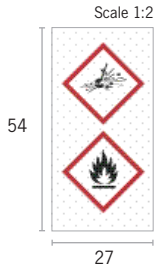

### Gs GHS double pictograms

Material							Quantity	Article
Luxotherm® L / Aluminium, anodised A							10 pieces	0009
	<i>Mat.</i>							
Order-No. L	36599	36600	36601	36602	36603	36604		
Price	€ 2,95	€ 2,95	€ 2,95	€ 2,95	€ 2,95	€ 2,95		
Order-No. A	36574	36575	36576	36577	36578	36579		
Price	€ 5,90	€ 5,90	€ 5,90	€ 5,90	€ 5,90	€ 5,90		
	<i>Mat.</i>							
Order-No. L	36605	36606	36607	36608	36609			
Price	€ 2,95	€ 2,95	€ 2,95	€ 2,95	€ 2,95			
Order-No. A	36580	36581	36582	36583	36584			
Price	€ 5,90	€ 5,90	€ 5,90	€ 5,90	€ 5,90			
	<i>Mat.</i>							
Order-No. L	36610	36611	36612	36613	36614			
Price	€ 2,95	€ 2,95	€ 2,95	€ 2,95	€ 2,95			
Order-No. A	36585	36586	36587	36588	36589			
Price	€ 5,90	€ 5,90	€ 5,90	€ 5,90	€ 5,90			
	<i>Mat.</i>							
Order-No. L	36615	36616	36617	36618				
Price	€ 2,95	€ 2,95	€ 2,95	€ 2,95				
Order-No. A	36590	36591	36592	36593				
Price	€ 5,90	€ 5,90	€ 5,90	€ 5,90				
	<i>Mat.</i>							
Order-No. L	36619	36620	36621	36622	36623			
Price	€ 2,95	€ 2,95	€ 2,95	€ 2,95	€ 2,95			
Order-No. A	36594	36595	36596	36597	36598			
Price	€ 5,90	€ 5,90	€ 5,90	€ 5,90	€ 5,90			

## 36 Series

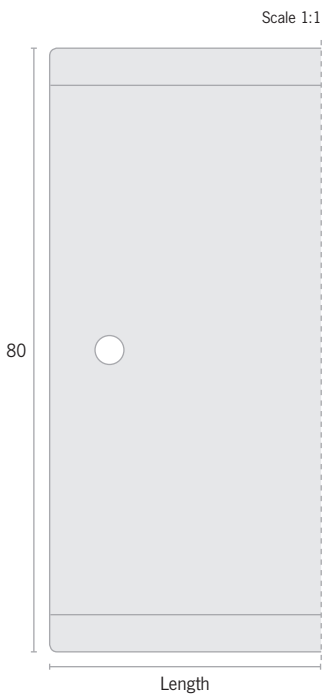

### Is Inserts

Standard sizes 36 up to 576 mm. Other sizes and prices on request.

### Sp Slide-in profile

Material		Quantity	Article				
Chlorid free plastic <b>K</b> / Aluminium, anodised <b>A</b>		5 pieces	0008				
Length	Length of inserts*	Order-No.	Price	Mat.	Order-No.	Price	Mat.
108 mm	36 / 72** mm	<b>K 6820</b>	€ 4,80	<b>A 6802</b>	<b>K 6802</b>	€ 7,20	<b>A 6802</b>
126 mm	54 / 90** mm	<b>K 6821</b>	€ 5,10	<b>A 6803</b>	<b>K 6803</b>	€ 7,60	<b>A 6803</b>
144 mm	72 / 108** mm	<b>K 566</b>	€ 5,40	<b>A 552</b>	<b>K 552</b>	€ 8,00	<b>A 552</b>
162 mm	90 / 126** mm	<b>K 6822</b>	€ 5,70	<b>A 6804</b>	<b>K 6804</b>	€ 8,40	<b>A 6804</b>
180 mm	108 / 144** mm	<b>K 567</b>	€ 6,00	<b>A 553</b>	<b>K 553</b>	€ 8,80	<b>A 553</b>
198 mm	126 / 162** mm	<b>K 6823</b>	€ 6,30	<b>A 6805</b>	<b>K 6805</b>	€ 9,20	<b>A 6805</b>
216 mm	144 / 180** mm	<b>K 568</b>	€ 6,60	<b>A 554</b>	<b>K 554</b>	€ 9,60	<b>A 554</b>
234 mm	162 / 198** mm	<b>K 6825</b>	€ 6,90	<b>A 6806</b>	<b>K 6806</b>	€ 10,00	<b>A 6806</b>
252 mm	180 / 216** mm	<b>K 569</b>	€ 7,20	<b>A 555</b>	<b>K 555</b>	€ 10,40	<b>A 555</b>
270 mm	198 / 234** mm	<b>K 6826</b>	€ 7,50	<b>A 6807</b>	<b>K 6807</b>	€ 10,80	<b>A 6807</b>
288 mm	216 / 252** mm	<b>K 570</b>	€ 7,80	<b>A 556</b>	<b>K 556</b>	€ 11,20	<b>A 556</b>
306 mm	234 / 270** mm	<b>K 6827</b>	€ 8,10	<b>A 6808</b>	<b>K 6808</b>	€ 11,60	<b>A 6808</b>
324 mm	252 / 288** mm	<b>K 571</b>	€ 8,40	<b>A 557</b>	<b>K 557</b>	€ 12,40	<b>A 557</b>
342 mm	270 / 306** mm	<b>K 6828</b>	€ 8,70	<b>A 6809</b>	<b>K 6809</b>	€ 13,20	<b>A 6809</b>
360 mm	288 / 324** mm	<b>K 572</b>	€ 9,00	<b>A 558</b>	<b>K 558</b>	€ 14,00	<b>A 558</b>
378 mm	306 / 342** mm	<b>K 6829</b>	€ 9,30	<b>A 6810</b>	<b>K 6810</b>	€ 14,80	<b>A 6810</b>
396 mm	324 / 360** mm	<b>K 573</b>	€ 9,60	<b>A 559</b>	<b>K 559</b>	€ 15,60	<b>A 559</b>
432 mm	360 / 396** mm	<b>K 574</b>	€ 9,90	<b>A 560</b>	<b>K 560</b>	€ 17,20	<b>A 560</b>
468 mm	396 / 432** mm	<b>K 575</b>	€ 10,20	<b>A 561</b>	<b>K 561</b>	€ 18,80	<b>A 561</b>
486 mm	414 / 450** mm	<b>K 6830</b>	€ 10,50	<b>A 6811</b>	<b>K 6811</b>	€ 20,40	<b>A 6811</b>
504 mm	432 / 468** mm	<b>K 576</b>	€ 10,80	<b>A 562</b>	<b>K 562</b>	€ 22,00	<b>A 562</b>
540 mm	468 / 504** mm	<b>K 577</b>	€ 11,10	<b>A 563</b>	<b>K 563</b>	€ 24,40	<b>A 563</b>
576 mm	504 / 540** mm	<b>K 578</b>	€ 11,70	<b>A 564</b>	<b>K 564</b>	€ 26,80	<b>A 564</b>
612 mm	540 / 576** mm	<b>K 579</b>	€ 12,30	<b>A 565</b>	<b>K 565</b>	€ 29,20	<b>A 565</b>

\*The number of symbols takes into account that there are always two additional outer elements.  
\*\*With half outer elements

### 36 Series

Scale 1:1

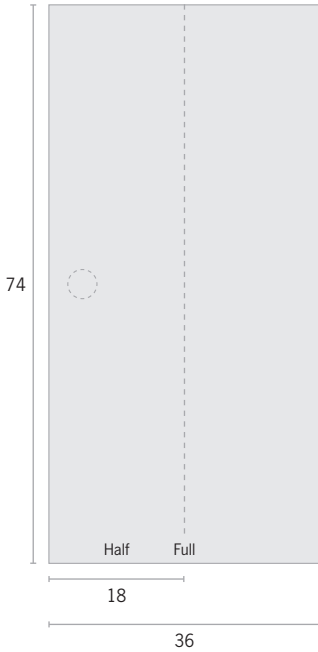

#### Oe Outer elements

Material		Quantity		Article																
Luxotherm® L / Aluminium, anodised A		10 pieces		0007																
<b>DIN 2403</b>																				
No colour		Oxygen		Water																
RAL5005		RAL6032		RAL3001																
RAL7004		Air																		
Neutral		Group 0		Group 1																
Group 2		Group 3																		
Design	Mat.	Full	Half	Full	Half															
without hole	Order-No. L	695	807	679	791															
	Price	€ 4,50	€ 5,25	€ 4,50	€ 5,25															
with hole	Order-No. L	694	806	678	790															
	Price	€ 4,50	€ 5,25	€ 4,50	€ 5,25															
<table border="0"> <tr> <td>Gases</td> <td>Acids</td> <td>Alkalis</td> <td>Liquids and fixed materials</td> <td>Other colours</td> </tr> <tr> <td>RAL1003</td> <td>RAL2010</td> <td>RAL4008</td> <td>RAL8002</td> <td>Black</td> </tr> <tr> <td>Group 4/5</td> <td>Group 6</td> <td>Group 7</td> <td>Group 8/9</td> <td>Zusatz</td> </tr> </table>						Gases	Acids	Alkalis	Liquids and fixed materials	Other colours	RAL1003	RAL2010	RAL4008	RAL8002	Black	Group 4/5	Group 6	Group 7	Group 8/9	Zusatz
Gases	Acids	Alkalis	Liquids and fixed materials	Other colours																
RAL1003	RAL2010	RAL4008	RAL8002	Black																
Group 4/5	Group 6	Group 7	Group 8/9	Zusatz																
Design	Mat.	Full	Half	Full	Half															
without hole	Order-No. L	687	799	689	801															
	Price	€ 4,50	€ 5,25	€ 4,50	€ 5,25															
with hole	Order-No. L	686	798	688	800															
	Price	€ 4,50	€ 5,25	€ 4,50	€ 5,25															
<b>NEN 3050</b>																				
No colour		Steam		Fire fighting																
RAL9006		RAL3000		RAL1004																
RAL4001		Alkalis																		
Group 4/5		Group 6		Group 7																
Group 8/9		Zusatz																		
Design	Mat.	Full	Half	Full	Half															
without hole	Order-No. L	695	807	729	765															
	Price	€ 4,50	€ 5,25	€ 4,50	€ 5,25															
with hole	Order-No. L	694	806	728	764															
	Price	€ 4,50	€ 5,25	€ 4,50	€ 5,25															
<table border="0"> <tr> <td>Air</td> <td>Oils and flammable liquids</td> <td>Acids</td> <td>Water</td> <td>Other liquids</td> </tr> <tr> <td>RAL5012</td> <td>RAL8001</td> <td>RAL2008</td> <td>RAL6010</td> <td>Black</td> </tr> </table>						Air	Oils and flammable liquids	Acids	Water	Other liquids	RAL5012	RAL8001	RAL2008	RAL6010	Black					
Air	Oils and flammable liquids	Acids	Water	Other liquids																
RAL5012	RAL8001	RAL2008	RAL6010	Black																
Design	Mat.	Full	Half	Full	Half															
without hole	Order-No. L	723	759	725	761															
	Price	€ 4,50	€ 5,25	€ 4,50	€ 5,25															
with hole	Order-No. L	722	758	724	760															
	Price	€ 4,50	€ 5,25	€ 4,50	€ 5,25															

Scale 1:1

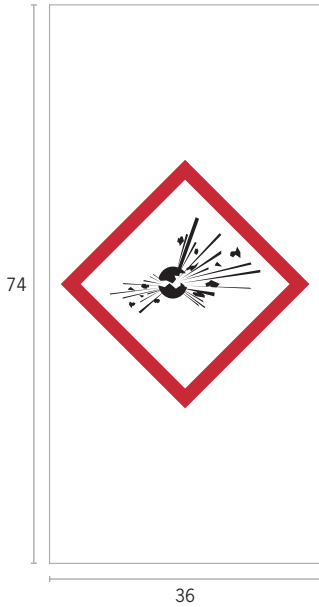

**Gs** GHS pictograms

Material	Quantity	Article
Luxotherm® L / Aluminium, anodised A	10 pieces	0009

	Mat.	GHS 01		GHS 02		GHS 03		GHS 04		GHS 05	
		36 mm	72 mm	36 mm	72 mm	36 mm	72 mm	36 mm	72 mm	36 mm	72 mm
Order-No.	L	513	33351	516	33352	519	33353	521	33354	524	33355
Price	L	€ 5,60	€ 9,80	€ 5,60	€ 9,80	€ 5,60	€ 9,80	€ 5,60	€ 9,80	€ 5,60	€ 9,80
Order-No.	A	488	33342	491	33343	494	33344	496	33345	499	33346
Price	A	€ 11,20	€ 19,95	€ 11,20	€ 19,95	€ 11,20	€ 19,95	€ 11,20	€ 19,95	€ 11,20	€ 19,95

	Mat.	GHS 06		GHS 07		GHS 08		GHS 09	
		36 mm	72 mm	36 mm	72 mm	36 mm	72 mm	36 mm	72 mm
Order-No.	L	526	33356	528	33357	531	33358	533	33359
Price	L	€ 5,60	€ 9,80	€ 5,60	€ 9,80	€ 5,60	€ 9,80	€ 5,60	€ 9,80
Order-No.	A	501	33347	503	33348	506	33349	508	33350
Price	A	€ 11,20	€ 19,95	€ 11,20	€ 19,95	€ 11,20	€ 19,95	€ 11,20	€ 19,95

Scale 1:1

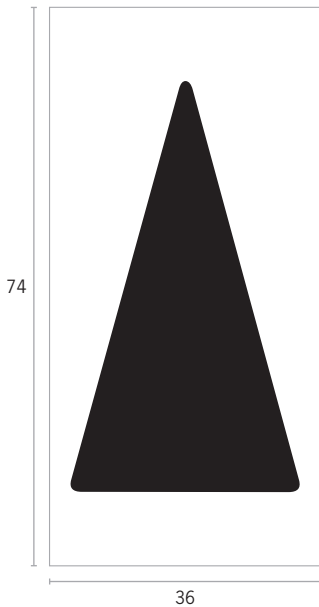

**Af** Flow direction arrows

Material	Quantity	Article
Luxotherm® L / Aluminium, anodised A	10 pieces	0009

	Mat.	Arrow 1		Arrow 2		Arrow 3		Arrow 4	
		36 mm	72 mm	36 mm	72 mm	36 mm	72 mm	36 mm	72 mm
Order-No.	L	534		535		30311		30312	
Price	L	€ 4,50		€ 4,50		€ 4,50		€ 4,50	
Order-No.	A	509		510		30309		30310	
Price	A	€ 9,00		€ 9,00		€ 9,00		€ 9,00	

## Pipe Labelling – Stickers and Tapes



Proper pipe identification not only poses fewer potential risks for your employees, but it also facilitates repair and maintenance work in industrial plants and power stations.

At the very least, and in accordance with the German regulation TRGS 201 (“Technical Rules for Hazardous Substances” 201), pipes must be labelled with the fluid conveyed and the flow direction. With our product range and know-how, we also provide our customers with the certainty that their labelling meets the requirements of DIN 2403.

### Product overview:

- **Pipe markers** – cost-effective solution for pipes with a small labelling area
- **Colour tape** – individually labelling of pipes according to the fluid conveyed
- **Arrow tape** – individually labelling of pipes according to the flow direction
- **Text tape** – readable from all sides because they are completely wrapped around the pipe
- **GHS tape** – for labelling hazardous substances in accordance with the GHS regulation

You can of course also label your pipes with the array of products from the slide-in system or printed and engraved signs. Contact us – we will gladly find the best solution for you.

### Specifics of our Pipe Markers and Tapes:

- Flame-resistant
- Self-extinguishing
- Extreme adhesive power
- Mostly resistant against acid and alkaline substances
- UV resistant
- Can be applied at temperatures of 5°C to 45°C
- Resistant to temperatures of -20°C to -110°C
- Mostly solvent resistant
- Weather-proof



## Pipe markers

Material	Temperature resistance	Quantity
Foil	-20 – 110°C	1 piece

### DIN 2403

Application	Colour	Additional colour	Text colour
Oxygen	RAL5005	–	RAL9003 (white)
Water	RAL6032	–	RAL9003 (white)
Steam	RAL3001	–	RAL9003 (white)
Air	RAL7004	–	RAL9004
Flammable gases	RAL1003	RAL3001	RAL9004
Non flammable gases	RAL1003	RAL9004	RAL9004
Acids	RAL2010	–	RAL9004
Alkalis	RAL4008	–	RAL9003 (white)
Flammable liquids and fixed materials	RAL8002	RAL3001	RAL9003 (white)
Non flammable liquids and fixed materials	RAL8002	RAL9004	RAL9003 (white)

### NEN 3050

Application	Colour
Alkalis	RAL4001
Fire fighting	RAL3000
Gases and liquid gases	RAL1004
Air	RAL5012
Oils and flammable liquids	RAL8001
Other liquids	RAL9004
Steam	RAL9006
Water	RAL6010
Acids (based on a recommendation of NWS)	RAL2008

### Distance of observation

The formula for calculating the distance of observation is:  $D = \frac{h \times Z}{\dots}$

D = distance of observation in m,  
h = font height in mm,  
Z = distance factor:  
300 for letters and symbols  
40 for safety symbols

### Dimensions and distance of observation



Width x Height (mm)	110 x 18	156 x 25	227 x 37	402 x 52	450 x 73	720 x 116
Font height (mm)	12	17	25	29	50	80
Distance of observation (m)	3,6	5,1	7,5	8,7	15	24

**Pm** Pipe markers

GHS tapes **Gt**

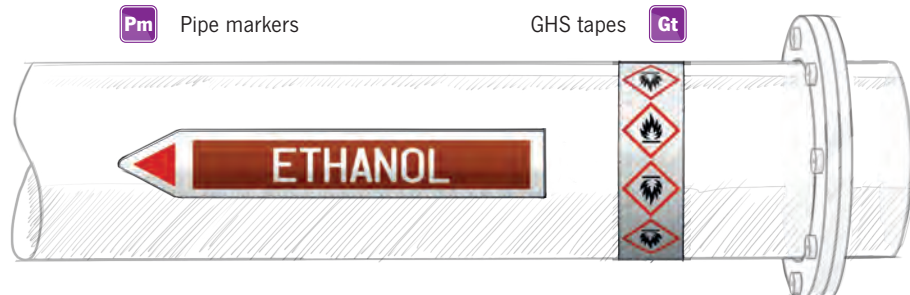

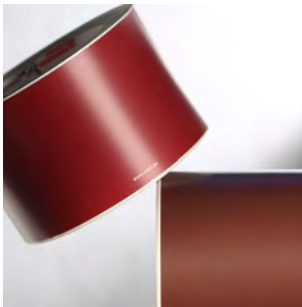

## Colour tapes

Material	Temperature resistance	Quantity	Article
Foil	-20 – 110°C	1 piece	0004

### DIN 2403

Width x Length	Application	Colour	Quantity		
			B = 35 mm	B = 75 mm	B = 150 mm
B x 25 m	Oxygen	RAL5005	<b>Order-No.</b> 903 Price € 35,00	<b>915</b> € 67,00	<b>927</b> € 115,00
B x 25 m	Water	RAL6032	<b>Order-No.</b> 904 Price € 35,00	<b>916</b> € 67,00	<b>928</b> € 115,00
B x 25 m	Steam	RAL3001	<b>Order-No.</b> 905 Price € 35,00	<b>917</b> € 67,00	<b>929</b> € 115,00
B x 25 m	Air	RAL7004	<b>Order-No.</b> 906 Price € 35,00	<b>918</b> € 67,00	<b>930</b> € 115,00
B x 25 m	Gases	RAL1003	<b>Order-No.</b> 907 Price € 35,00	<b>919</b> € 67,00	<b>931</b> € 115,00
B x 25 m	Acids	RAL2010	<b>Order-No.</b> 908 Price € 35,00	<b>920</b> € 67,00	<b>932</b> € 115,00
B x 25 m	Alkalis	RAL4008	<b>Order-No.</b> 909 Price € 35,00	<b>921</b> € 67,00	<b>933</b> € 115,00
B x 25 m	Liquids and fixed materials	RAL8002	<b>Order-No.</b> 910 Price € 35,00	<b>922</b> € 67,00	<b>934</b> € 115,00
B x 25 m	Fire fighting water	RAL3001 RAL6032	<b>Order-No.</b> 911 Price € 35,00	<b>923</b> € 67,00	<b>935</b> € 115,00
B x 25 m	Fire fighting gas	RAL3001 RAL1003	<b>Order-No.</b> 912 Price € 35,00	<b>924</b> € 67,00	<b>936</b> € 115,00
B x 25 m	Fire fighting steam	RAL3001 RAL3001	<b>Order-No.</b> 913 Price € 35,00	<b>925</b> € 67,00	<b>937</b> € 115,00
B x 25 m	Fire fighting others	RAL3001 RAL9004	<b>Order-No.</b> 914 Price € 35,00	<b>926</b> € 67,00	<b>938</b> € 115,00

### NEN 3050

Width x Length	Application	Colour	Quantity		
			B = 35 mm	B = 75 mm	B = 150 mm
B x 25 m	Alkalis	RAL4001	<b>Order-No.</b> 939 Price € 35,00	<b>948</b> € 67,00	<b>957</b> € 115,00
B x 25 m	Fire fighting	RAL3000	<b>Order-No.</b> 940 Price € 35,00	<b>949</b> € 67,00	<b>958</b> € 115,00
B x 25 m	Gases and liquid gases	RAL1004	<b>Order-No.</b> 941 Price € 35,00	<b>950</b> € 67,00	<b>959</b> € 115,00
B x 25 m	Air	RAL5012	<b>Order-No.</b> 942 Price € 35,00	<b>951</b> € 67,00	<b>960</b> € 115,00
B x 25 m	Oils and flammable liquids	RAL8001	<b>Order-No.</b> 943 Price € 35,00	<b>952</b> € 67,00	<b>961</b> € 115,00
B x 25 m	Other liquids	RAL9004	<b>Order-No.</b> 944 Price € 35,00	<b>953</b> € 67,00	<b>962</b> € 115,00
B x 25 m	Steam	RAL9006	<b>Order-No.</b> 945 Price € 35,00	<b>954</b> € 67,00	<b>963</b> € 115,00
B x 25 m	Water	RAL6010	<b>Order-No.</b> 946 Price € 35,00	<b>955</b> € 67,00	<b>964</b> € 115,00
B x 25 m	Acids (recommendation of NWS)	RAL2008	<b>Order-No.</b> 947 Price € 35,00	<b>956</b> € 67,00	<b>965</b> € 115,00

**Ct** Colour tapes







## Arrow tapes

Material	Temperature resistance	Quantity	Article
Foil	-20 – 110°C	1 piece	0006

### DIN 2403

Width x Length	Application	Colour	Arrow colour	B = 35 mm B = 75 mm B = 150 mm		
				Order-No.	Price	Order-No.
B x 25 m	Oxygen	RAL5005		<b>811</b> € 35,00	<b>831</b> € 67,00	<b>851</b> € 115,00
B x 25 m	Water	RAL6032		<b>812</b> € 35,00	<b>832</b> € 67,00	<b>852</b> € 115,00
B x 25 m	Steam	RAL3001		<b>813</b> € 35,00	<b>833</b> € 67,00	<b>853</b> € 115,00
B x 25 m	Air	RAL7004		<b>814</b> € 35,00	<b>834</b> € 67,00	<b>854</b> € 115,00
B x 25 m	Flammable gases	RAL1003		<b>815</b> € 35,00	<b>835</b> € 67,00	<b>855</b> € 115,00
B x 25 m	Non flammable gases	RAL1003		<b>816</b> € 35,00	<b>836</b> € 67,00	<b>856</b> € 115,00
B x 25 m	Acids	RAL2010		<b>817</b> € 35,00	<b>837</b> € 67,00	<b>857</b> € 115,00
B x 25 m	Alkalis	RAL4008		<b>818</b> € 35,00	<b>838</b> € 67,00	<b>858</b> € 115,00
B x 25 m	Flammable liquids and fixed materials	RAL8002		<b>819</b> € 35,00	<b>839</b> € 67,00	<b>859</b> € 115,00
B x 25 m	Non flammable liquids and fixed materials	RAL8002		<b>820</b> € 35,00	<b>840</b> € 67,00	<b>860</b> € 115,00
B x 25 m	Direction	No colour		<b>821</b> € 35,00	<b>841</b> € 67,00	<b>861</b> € 115,00
B x 25 m	Direction	No colour		<b>35281</b> € 35,00	<b>35282</b> € 67,00	<b>35283</b> € 115,00

### NEN 3050

Width x Length	Application	Colour	Arrow colour	B = 35 mm B = 75 mm B = 150 mm		
				Order-No.	Price	Order-No.
B x 25 m	Alkalis	RAL4001		<b>822</b> € 35,00	<b>842</b> € 67,00	<b>862</b> € 115,00
B x 25 m	Fire fighting	RAL3000		<b>823</b> € 35,00	<b>843</b> € 67,00	<b>863</b> € 115,00
B x 25 m	Gases and liquid gases	RAL1004		<b>824</b> € 35,00	<b>844</b> € 67,00	<b>864</b> € 115,00
B x 25 m	Air	RAL5012		<b>825</b> € 35,00	<b>845</b> € 67,00	<b>865</b> € 115,00
B x 25 m	Oils and flammable liquids	RAL8001		<b>826</b> € 35,00	<b>846</b> € 67,00	<b>866</b> € 115,00
B x 25 m	Other liquids	RAL9004		<b>827</b> € 35,00	<b>847</b> € 67,00	<b>867</b> € 115,00
B x 25 m	Steam	RAL9006		<b>828</b> € 35,00	<b>848</b> € 67,00	<b>868</b> € 115,00
B x 25 m	Water	RAL6010		<b>829</b> € 35,00	<b>849</b> € 67,00	<b>869</b> € 115,00
B x 25 m	Acids (recommendation of NWS)	RAL2008		<b>830</b> € 35,00	<b>850</b> € 67,00	<b>870</b> € 115,00

**At** Arrow tapes

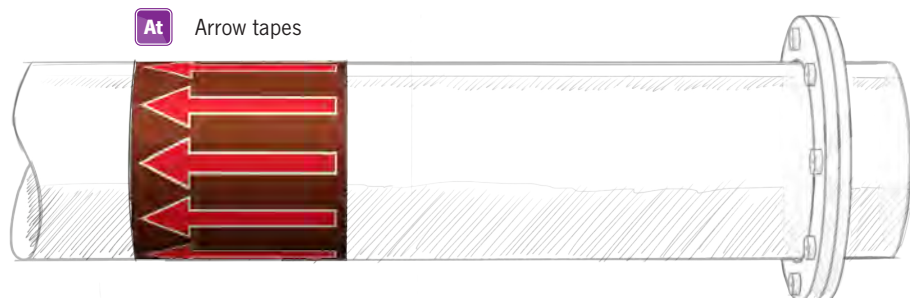



### Text tapes

Material	Temperature resistance	Quantity
Foil	-20 – 110°C	1 piece

#### DIN 2403

Width x Length	Application	Colour	B = 35 mm	B = 75 mm	B = 150 mm
B x 25 m	Oxygen	RAL5005	All prices on request	All prices on request	All prices on request
B x 25 m	Water	RAL6032			
B x 25 m	Steam	RAL3001			
B x 25 m	Air	RAL7004			
B x 25 m	Flammable gases	RAL1003			
B x 25 m	Non flammable gases	RAL1003			
B x 25 m	Acids	RAL2010			
B x 25 m	Alkalis	RAL4008			
B x 25 m	Flammable liquids and fixed materials	RAL8002			
B x 25 m	Non flammable liquids and fixed materials	RAL8002			
B x 25 m	Direction	No colour			

#### NEN 3050

Width x Length	Application	Colour	B = 35 mm	B = 75 mm	B = 150 mm
B x 25 m	Alkalis	RAL4001	All prices on request	All prices on request	All prices on request
B x 25 m	Fire fighting	RAL3000			
B x 25 m	Gases and liquid gases	RAL1004			
B x 25 m	Air	RAL5012			
B x 25 m	Oils and flammable liquids	RAL8001			
B x 25 m	Other liquids	RAL9004			
B x 25 m	Steam	RAL9006			
B x 25 m	Water	RAL6010			
B x 25 m	Acids (recommendation of NWS)	RAL2008			







Tt Text tapes







## GHS tapes

Material	Temperature resistance	Quantity	Article
Foil	-20 – 110°C	1 piece	0005

Width x Length	GHS 01	GHS 02	GHS 03	GHS 04	GHS 05	GHS 06
<b>35 mm x 25 m</b>						
<b>Order-No.</b>	<b>871</b>	<b>872</b>	<b>873</b>	<b>874</b>	<b>875</b>	<b>876</b>
<b>Price</b>	€ 35,00	€ 35,00	€ 35,00	€ 35,00	€ 35,00	€ 35,00
<b>75 mm x 25 m</b>	<b>Order-No. 882</b>	<b>885</b>	<b>888</b>	<b>890</b>	<b>893</b>	<b>895</b>
<b>Price</b>	€ 67,00	€ 67,00	€ 67,00	€ 67,00	€ 67,00	€ 67,00
<b>150 mm x 25 m</b>	<b>Order-No. 33272</b>	<b>33273</b>	<b>33274</b>	<b>33275</b>	<b>33276</b>	<b>33277</b>
<b>Price</b>	€ 115,00	€ 115,00	€ 115,00	€ 115,00	€ 115,00	€ 115,00

Width x Length	GHS 07	GHS 08	GHS 09
<b>35 mm x 25 m</b>			
<b>Order-No.</b>	<b>877</b>	<b>878</b>	<b>879</b>
<b>Price</b>	€ 35,00	€ 35,00	€ 35,00
<b>75 mm x 25 m</b>	<b>Order-No. 897</b>	<b>900</b>	<b>902</b>
<b>Price</b>	€ 67,00	€ 67,00	€ 67,00
<b>150 mm x 25 m</b>	<b>Order-No. 33278</b>	<b>33279</b>	<b>33280</b>
<b>Price</b>	€ 115,00	€ 115,00	€ 115,00

**Gt** GHS tapes





**Module system and adhesive film stickers**

Our module system allows for flexible combinations of all pipe labelling stickers and tapes. You can combine different pipe labelling variants (colour, arrow and GHS tapes) and complement with an adhesive film sticker. The size of this, sticker showing the actual name of the substance within the pipe, can be adjusted individually. The height of the font is determined according to available place and diameter of the pipe and requested distance of observation in order to ensure the readability of the information even from great distance.

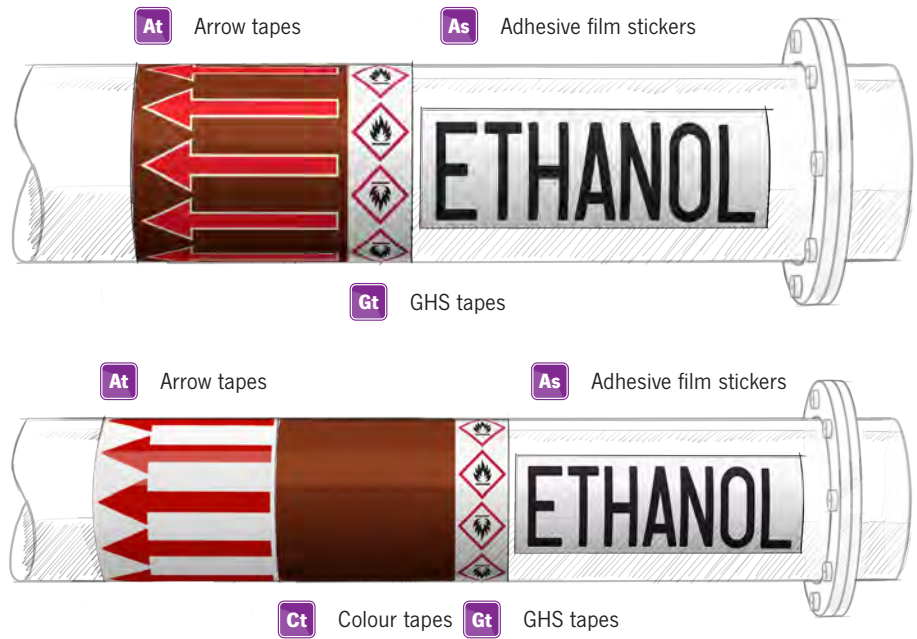

# Tank Labelling



Tanks containing hazardous substances must be labelled according to German regulation TRGS 201 in order to ensure correct identification of the contents. The information must be mounted in a clearly visible, safe and durable manner. On the one hand, this aids in the work of your responsible employees, and on the other, easy-to-read and quickly comprehensible labels facilitate the tasks that fire brigades and rescue workers perform in emergency situations.

Using various designs, we adapt the labelling to suit your situation on site. As a rule, flexible basic materials or films are printed in combination with the desired information on the tanks' contents and the necessary hazard indicators. In doing so, the size of the labelling should be adapted not only to the on-site conditions and installation location, but also to the bend in the base area and the desired observations distance. In Germany, it is mandatory to label and tanks with GHS pictograms. In addition, some tanks are

furnished with hazardous diamonds or safety and identification numbers according to their hazard class, displaying the relevant hazards. Furthermore, information about volume, inner pressure or a numeric order might be required. We are prepared to address your individual needs regarding contents, manufacturing and fastening.



### NFPA 704 Hazard Diamond

#### Standard System for the Identification of the Hazard of Materials for Emergency Response

In case of accidents involving hazardous substances, the hazard diamond helps safety and rescue forces to immediately evaluate possible dangers. The hazard diamond shows four coloured fields: blue for safety hazards, red for flammability, yellow for instable substances and a white field at the bottom for specific warning information.

Health Hazard	
0	Poses no health hazard
1	Minor hazard   breathing apparatus recommended
2	Dangerous   Wear light protective clothing and breathing apparatus in danger zone
3	Very dangerous   Wear full protective clothing and breathing apparatus in danger zone
4	Can be lethal   Avoid any contact with vapours or liquids without suitable protective equipment
Flammability	
0	Materials will not burn under typical conditions
1	Materials require considerable preheating before ignition/ combustion can occur
2	Materials must be moderately heated before ignition can occur
3	Materials can be ignited under almost all ambient temperature
4	Materials will burn readily at normal temperatures
Instability	
0	Normally stable
1	Can become unstable at elevated temperatures   Protection measures required
2	Violent chemical reaction possible; advanced protection measures required; execute fire-fighting only from safe distance
3	Capable of detonation or explosive decomposition when heated or severely shocked; establish a safety zone; execute fire-fighting only from safe distance
4	Readily capable of detonation or explosive decomposition; establish a safety zone; evacuate area in case of fire
(empty)	Use water as extinguishing agent
W	Do not use water as extinguishing agent
OX	Oxidizer, chemicals burn without air supply
ACID	Strong acid
ALK	Strong base
COR	Strong corrosive
BIO	Biological hazard
	Radioactive hazard

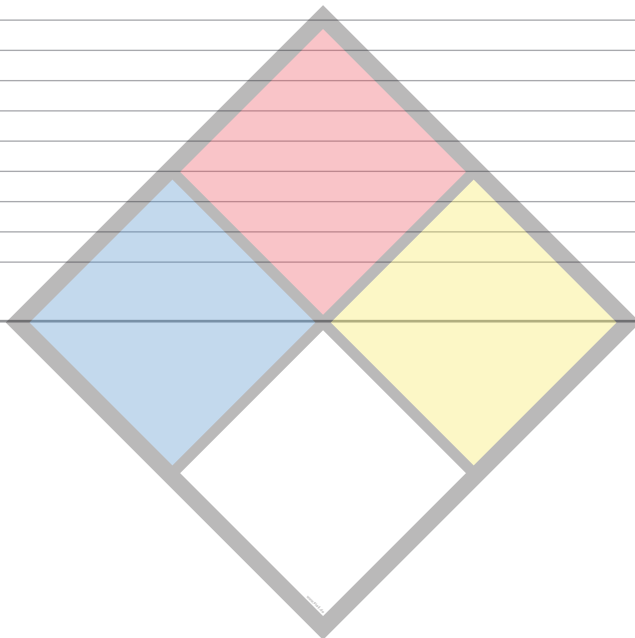

2000 mm

400 mm

**T-501**  
13150m<sup>3</sup>  
METHANOL

336  
1230

2000 mm

700 mm

**T866**  
ALLYLCHLORID

1500 mm

850 mm

**V2502a**  
H<sub>2</sub>S 20m<sup>3</sup>  
HYDROGEN SULPHIDE



# Pre-Labeling

Pre-labelling tags make things easier for both you and us. They are installed as temporary labels in the plant during construction and renovation works and are then replaced by the significantly more durable and uniformly recognisable plant labelling upon the launch of plant operations or thereafter. For this temporary application, we offer you a good price-performance ratio with regard to durability, ease of use and cost.



## Pre-labelling

Material		Quantity	Article	
Plastic <b>K</b> / Painted steel sheet <b>S</b>		100 pieces	0010	
Width x Height x Strength	Colour	Mat.	Mat.	
120 x 65 x 0,03 mm	white	<b>Order-No.</b> <b>K</b> 271 <b>Price</b> € 14,00	<b>S</b> 277	€ 24,00
120 x 65 x 0,03 mm	red	<b>Order-No.</b> <b>K</b> 272 <b>Price</b> € 14,00	<b>S</b> 278	€ 24,00
120 x 65 x 0,03 mm	yellow	<b>Order-No.</b> <b>K</b> 273 <b>Price</b> € 14,00	<b>S</b> 279	€ 24,00
120 x 65 x 0,03 mm	green	<b>Order-No.</b> <b>K</b> 274 <b>Price</b> € 14,00	<b>S</b> 280	€ 24,00
120 x 65 x 0,03 mm	blue	<b>Order-No.</b> <b>K</b> 275 <b>Price</b> € 14,00	<b>S</b> -	-
120 x 65 x 0,03 mm	orange	<b>Order-No.</b> <b>K</b> 276 <b>Price</b> € 14,00	<b>S</b> -	-



## Seals

Material		Quantity	Article	
Lead		1 piece / 100 pieces	0019	
Application	Quantity	Order-No.	Article	
For seals wire	1 piece	<b>Price</b> € 0,20	<b>14505</b>	
	100 pieces	<b>Price</b> € 5,00	<b>102</b>	

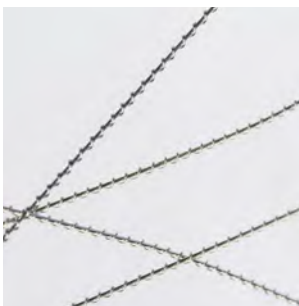

## Seal wire

Material		Quantity	Article	
Galvanized steel <b>S</b> / Stainless steel <b>E</b>		100 pieces	0020	
Length	Application	Mat.	Mat.	
230 mm	Pre labelling	<b>Order-No.</b> <b>S</b> 101 <b>Price</b> € 4,00	<b>E</b> 100	€ 18,00



# Fastening and Accessories

In order for a sign to aid in providing comprehension, safety and orientation, it must be properly installed. Our fastening products therefore offer the right solution for each of our plant labelling systems. Tried, tested and durable, the different sizes and types of signs can be fastened to the necessary installation points in a clearly visible manner.

Our sign-bracket, which comes in various designs, serves as the base. It matches the sizes and perforations of our original Stell "Stecksystem", the slide-in system and the standardised dimensions of the engraved and printed signs. The sign-bracket is fixed with our pipe clamp, which allows for reliable labelling that is gentle on the object to which it is attached. Our range is broadened by additional fastenings and fastening accessories. For further questions regarding our products our sales team is always at your disposal.



## **Sb** Sign bracket

Material	Quantity	Article
Aluminium AlMg 3 <b>A</b> / Stainless steel <b>E</b>	1 piece	0015

Height	Length	Order-No.	Price	Mat.	Order-No.	Price	Mat.	Height	Length	Order-No.	Price	Mat.	Order-No.	Price	Mat.
18 mm	52 mm	19924	€ 1,15	<b>A</b>	19895	€ 1,65	<b>E</b>	29 mm	52 mm	21371	€ 1,20	<b>A</b>	20418	€ 1,75	<b>E</b>
	70 mm	181	€ 1,20	<b>A</b>	197	€ 1,70	<b>E</b>		70 mm	187	€ 1,25	<b>A</b>	203	€ 1,80	<b>E</b>
	88 mm	182	€ 1,25	<b>A</b>	198	€ 1,75	<b>E</b>		88 mm	188	€ 1,30	<b>A</b>	204	€ 1,85	<b>E</b>
	106 mm	183	€ 1,30	<b>A</b>	199	€ 1,80	<b>E</b>		106 mm	189	€ 1,35	<b>A</b>	205	€ 1,90	<b>E</b>
	124 mm	184	€ 1,35	<b>A</b>	200	€ 1,85	<b>E</b>		124 mm	190	€ 1,40	<b>A</b>	206	€ 1,95	<b>E</b>
	142 mm	185	€ 1,40	<b>A</b>	201	€ 1,90	<b>E</b>		142 mm	191	€ 1,55	<b>A</b>	207	€ 2,10	<b>E</b>
	160 mm	186	€ 1,45	<b>A</b>	202	€ 1,95	<b>E</b>		160 mm	192	€ 1,70	<b>A</b>	208	€ 2,25	<b>E</b>
	178 mm	123	€ 2,20	<b>A</b>	152	€ 2,55	<b>E</b>		178 mm	129	€ 2,35	<b>A</b>	158	€ 3,00	<b>E</b>
	196 mm	124	€ 2,30	<b>A</b>	153	€ 2,65	<b>E</b>		196 mm	130	€ 2,50	<b>A</b>	159	€ 3,15	<b>E</b>
	214 mm	125	€ 2,40	<b>A</b>	154	€ 2,75	<b>E</b>		214 mm	131	€ 2,65	<b>A</b>	160	€ 3,30	<b>E</b>
232 mm	126	€ 2,50	<b>A</b>	155	€ 2,85	<b>E</b>	232 mm	132	€ 2,80	<b>A</b>	161	€ 3,45	<b>E</b>		
250 mm	127	€ 2,60	<b>A</b>	156	€ 2,95	<b>E</b>	250 mm	133	€ 2,95	<b>A</b>	162	€ 3,60	<b>E</b>		
268 mm	128	€ 2,70	<b>A</b>	157	€ 3,05	<b>E</b>	268 mm	134	€ 3,10	<b>A</b>	163	€ 3,75	<b>E</b>		

Height	Length	Order-No.	Price	Mat.	Order-No.	Price	Mat.	Height	Length	Order-No.	Price	Mat.	Order-No.	Price	Mat.
40 mm	88 mm	135	€ 1,40	<b>A</b>	164	€ 2,00	<b>E</b>	49 mm	88 mm	6775	€ 1,50	<b>A</b>	6776	€ 2,15	<b>E</b>
	106 mm	136	€ 1,45	<b>A</b>	165	€ 2,05	<b>E</b>		106 mm	193	€ 1,60	<b>A</b>	209	€ 2,25	<b>E</b>
	124 mm	137	€ 1,50	<b>A</b>	166	€ 2,10	<b>E</b>		124 mm	194	€ 1,70	<b>A</b>	210	€ 2,35	<b>E</b>
	142 mm	138	€ 1,65	<b>A</b>	167	€ 2,25	<b>E</b>		142 mm	195	€ 1,90	<b>A</b>	211	€ 2,55	<b>E</b>
	160 mm	139	€ 1,80	<b>A</b>	168	€ 2,40	<b>E</b>		160 mm	196	€ 2,10	<b>A</b>	212	€ 2,75	<b>E</b>
	178 mm	140	€ 2,10	<b>A</b>	169	€ 2,90	<b>E</b>		178 mm	146	€ 2,45	<b>A</b>	175	€ 3,30	<b>E</b>
	196 mm	141	€ 2,40	<b>A</b>	170	€ 3,20	<b>E</b>		196 mm	147	€ 2,80	<b>A</b>	176	€ 3,65	<b>E</b>
	214 mm	142	€ 2,85	<b>A</b>	171	€ 3,70	<b>E</b>		214 mm	148	€ 3,30	<b>A</b>	177	€ 4,15	<b>E</b>
	232 mm	143	€ 3,30	<b>A</b>	172	€ 4,20	<b>E</b>		232 mm	149	€ 3,80	<b>A</b>	178	€ 4,65	<b>E</b>
	250 mm	144	€ 3,75	<b>A</b>	173	€ 4,70	<b>E</b>		250 mm	150	€ 4,30	<b>A</b>	179	€ 5,15	<b>E</b>
268 mm	145	€ 4,20	<b>A</b>	174	€ 5,20	<b>E</b>	268 mm	151	€ 4,80	<b>A</b>	180	€ 5,65	<b>E</b>		



**Pc** Pipe clamp

Material		Quantity	Article
Stainless steel <b>E</b>		25 pieces	0012

Width	Range	Order-No.	Price	Mat.
9 mm	Ø 08 - 12 mm	<b>E</b> 243	€ 22,50	
	Ø 10 - 16 mm	<b>E</b> 244	€ 23,00	
	Ø 12 - 20 mm	<b>E</b> 245	€ 23,50	
	Ø 16 - 25 mm	<b>E</b> 246	€ 25,00	
	Ø 20 - 32 mm	<b>E</b> 247	€ 26,50	
	Ø 25 - 40 mm	<b>E</b> 248	€ 28,00	
	Ø 32 - 50 mm	<b>E</b> 249	€ 29,50	
	Ø 40 - 60 mm	<b>E</b> 250	€ 31,00	
	Ø 50 - 70 mm	<b>E</b> 251	€ 32,50	
	Ø 60 - 80 mm	<b>E</b> 252	€ 34,00	
	Ø 70 - 90 mm	<b>E</b> 253	€ 35,50	
	Ø 80 - 100 mm	<b>E</b> 254	€ 37,00	
	Ø 90 - 110 mm	<b>E</b> 255	€ 38,50	
	Ø 100 - 120 mm	<b>E</b> 256	€ 40,00	
	Ø 110 - 130 mm	<b>E</b> 257	€ 45,00	
	Ø 130 - 150 mm	<b>E</b> 258	€ 52,00	
	Ø 150 - 170 mm	<b>E</b> 259	€ 59,00	
	Ø 170 - 190 mm	<b>E</b> 260	€ 66,00	
	Ø 190 - 210 mm	<b>E</b> 261	€ 73,00	
	Ø 210 - 230 mm	<b>E</b> 262	€ 80,00	
Ø 230 - 250 mm	<b>E</b> 263	€ 88,00		
Ø 250 - 270 mm	<b>E</b> 264	€ 96,00		
Ø 270 - 290 mm	<b>E</b> 32111	€ 104,00		
Ø 290 - 310 mm	<b>E</b> 265	€ 112,00		
Ø 310 - 330 mm	<b>E</b> 32112	€ 120,00		



Cable ties

Material		Quantity	Article
Plastic, black and choride free		25 pieces	0011

Width x Length	Order-No.	Price
2,5 x 100 mm	<b>E</b> 266	€ 1,25
2,5 x 202 mm	<b>E</b> 267	€ 3,15
4,8 x 370 mm	<b>E</b> 33844	€ 8,50
9 x 430 mm	<b>E</b> 268	€ 14,75
9 x 812 mm	<b>E</b> 269	€ 27,35
9 x 1070 mm	<b>E</b> 270	€ 38,65



## Adhesive foam tape

Material		Quantity	Article	
Polyethylene foam		1 piece	0021	
Width	Application	Length 10 m    Length 50 m		
9 mm, perforated	45 series	<b>Order-No.</b> Price	<b>89</b> € 13,50	-
19 mm, perforated	6/9 series	<b>Order-No.</b> Price	<b>90</b> € 15,00	-
38 mm	18 series	<b>Order-No.</b> Price	<b>92</b> € 16,50	<b>6856</b> € 80,00
58 mm	27 series	<b>Order-No.</b> Price	<b>938</b> € 18,00	<b>6858</b> € 88,00
78 mm	36 series	<b>Order-No.</b> Price	<b>6859</b> € 23,00	<b>99</b> € 99,00



## Locks for hanger strap

Material		Quantity	Article	
Polyamide <b>P</b> / Galvanized steel <b>S</b> / Stainless steel <b>E</b>		25 pieces	0014	
Application		Mat.		
For 8 mm smoothed polyamide band	<b>Order-No.</b> Price	<b>P</b>	<b>218</b> € 7,25	
For 9 mm embossed steel band	<b>Order-No.</b> Price	<b>S</b>	<b>214</b> € 19,75	
For 7 mm embossed inox band	<b>Order-No.</b> Price	<b>E</b>	<b>213</b> € 22,50	
For 9 mm embossed inox band	<b>Order-No.</b> Price	<b>E</b>	<b>215</b> € 24,75	



## Hanger strap

Material		Quantity	Article	
Galvanized steel <b>S</b> / Stainless steel <b>E</b> / Polyamide <b>P</b>		1 piece	0013	
Width x Length	Design	Mat.		
9 mm x 30 m	Embossed	<b>Order-No.</b> Price	<b>S</b>	<b>220</b> € 30,60
7 mm x 25 m	Embossed	<b>Order-No.</b> Price	<b>E</b>	<b>219</b> € 33,75
9 mm x 30 m	Embossed	<b>Order-No.</b> Price	<b>E</b>	<b>221</b> € 35,60
8 mm x 50 m	Smooth	<b>Order-No.</b> Price	<b>P</b>	<b>223</b> € 40,00



## Steel band, PVC coated

Material		Quantity	Article	
Galvanized steel <b>S</b> / Stainless steel <b>E</b>		1 piece	0022	
Diameter	Design	1 metre    100 metres    125 metres		
Ø 2 mm	Steel/Plastic	<b>Order-No.</b> Price	<b>14529</b> € 1,15	<b>87</b> € 118,00
	Stainless steel/Plastic	<b>Order-No.</b> Price	<b>14531</b> € 1,25	<b>47510</b> € 142,50



## Seals

Material	Quantity	Article
Aluminium AlMg 3 <b>A</b> / Stainless steel <b>E</b>	1 piece / 100 pieces	0019
<i>Application</i>	<i>Quantity</i>	<i>Mat.</i>
For coated steel and coated stainless steel band	1 piece	<b>A</b> <b>14507</b> € 0,06
For ball chains	1 piece	<b>E</b> <b>14508</b> € 0,20



## **Br** Blind rivets

Material	Quantity	Article
Aluminium <b>A</b> / Plastic <b>K</b> / Stainless steel <b>E</b>	500 pieces	0018
<i>Width x Height</i>	<i>Application</i>	<i>Material sleeve</i> <i>Material pen</i>
3,0 x 4,5 mm	For bondings	Plastic                  Plastic
3,0 x 5,5 mm	For direct riveting	
3,0 x 4,0 mm	For bondings	Aluminium              Stainless steel
3,2 x 7,9 mm	For direct riveting	
		<i>Mat.</i>
	<b>Order-No.</b> <b>109</b>	<b>K / K</b> <b>109</b>
	Price	€ 24,00
	<b>Order-No.</b> <b>116</b>	<b>K / K</b> <b>116</b>
	Price	€ 25,00
	<b>Order-No.</b> <b>106</b>	<b>A / E</b> <b>106</b>
	Price	€ 34,00
	<b>Order-No.</b> <b>110</b>	<b>A / E</b> <b>110</b>
	Price	€ 35,00



## Bar holder

Material	Quantity	Article
Aluminium AlMg 3 <b>A</b> / Stainless steel <b>E</b>	10 pieces	0023
<i>Width x Length</i>	<i>Hole</i>	<i>Mat.</i> <i>Mat.</i>
30 x 110 mm	Ø 8,5 mm	<b>A</b> <b>82</b> <b>E</b> <b>77</b> Price € 12,10 € 17,10
	Ø 10,5 mm	<b>A</b> <b>83</b> <b>E</b> <b>78</b> Price € 12,10 € 17,10
	Ø 12,5 mm	<b>A</b> <b>84</b> <b>E</b> <b>79</b> Price € 12,10 € 17,10
	Ø 16,5 mm	<b>A</b> <b>85</b> <b>E</b> <b>80</b> Price € 12,10 € 17,10
	Ø 20,5 mm	<b>A</b> <b>86</b> <b>E</b> <b>81</b> Price € 12,10 € 17,10
30 x 120 mm	open	<b>A</b> <b>11114</b> <b>E</b> <b>11113</b> Price € 12,20 € 17,20



## Fastening cubes

Material		Quantity	Article
Aluminium <b>A</b> / Stainless steel <b>E</b>		20 pieces	0017
<i>Width x Height x Depth</i>	<i>Application</i>	<i>Mat.</i>	<i>Mat.</i>
15 x 15 x 15 mm	For pipe marking	Order-No. <b>A</b> 117 Price € 14,00	Order-No. <b>E</b> 118 Price € 17,00



## Keyrings

Material		Quantity	Article
Steel nickel-plated <b>S</b> / Stainless steel <b>E</b>		1 piece	0104
<i>Diameter</i>	<i>Application</i>	<i>Mat.</i>	<i>Mat.</i>
Ø 20,4 mm	For pipe marking	Order-No. <b>S</b> 18525 Price € 0,30	Order-No. <b>E</b> 18524 Price € 0,40



## Ball Chain

Material		Quantity	Article
Stainless steel		1 piece	0022
<i>Diameter x Length</i>	<i>Application</i>	<i>Order-No.</i>	<i>Price</i>
Ø 2 mm x 15 cm	For pipe marking	14526	€ 0,85
Ø 2 mm x 1 m	For pipe marking	Order-No. 14527 Price	€ 3,50
Ø 2 mm x 50 m	For pipe marking	Order-No. 14528 Price	€ 125,00



## Link Chain

Material		Quantity	Article
Steel nickel-plated <b>S</b> / Stainless steel <b>E</b>		1 piece	0022
<i>Diameter x Length</i>	<i>Application</i>	<i>Mat.</i>	<i>Mat.</i>
Ø 8 mm x 1 m	For pipe marking	Order-No. <b>S</b> 30233 Price € 2,40	Order-No. <b>E</b> 30232 Price € 6,70



### Rivet gun

	Quantity	Article
	1 piece	0091

*Application*

For all riveting work

<b>Order-No.</b>	<b>6770</b>
Price	€ 39,00



### Remove rivet gun

	Quantity	Article
	1 piece	0091

*Application*

For loosening of riveted joints

<b>Order-No.</b>	<b>5455</b>
Price	€ 195,00



### Tool for tension /cutting

	Quantity	Article
	1 piece	0091

*Application*

For processing the polyamide hanger strap

<b>Order-No.</b>	<b>5674</b>
Price	€ 245,00



### Cartridge skeleton gun

	Quantity	Article
	1 piece	0091

*Application*

For adhesives and sealants from the cartridge

<b>Order-No.</b>	<b>5456</b>
Price	€ 12,00



### Tube of glue

	Quantity	Article
	1 piece	0091

*Design*

Cartridge, 310 ml

*Application*

For the assembly of signs, transparent

<b>Order-No.</b>	<b>47477</b>
Price	€ 16,00



### Cleaner Spray

		Quantity	Article
		1 piece	0091
<i>Design</i>	<i>Application</i>		
Spray can, 500 ml	For degreasing metallic surfaces, glass and ceramics (check suitability before use)	<b>Order-No.</b> Price	<b>33847</b> € 11,50



### Surface cleaner

		Quantity	Article
		1 piece	0091
<i>Design</i>	<i>Application</i>		
Spray can, 500 ml	For cleaning heavily soiled surfaces	<b>Order-No.</b> Price	<b>33848</b> € 6,50

# Plans for Process Engineering

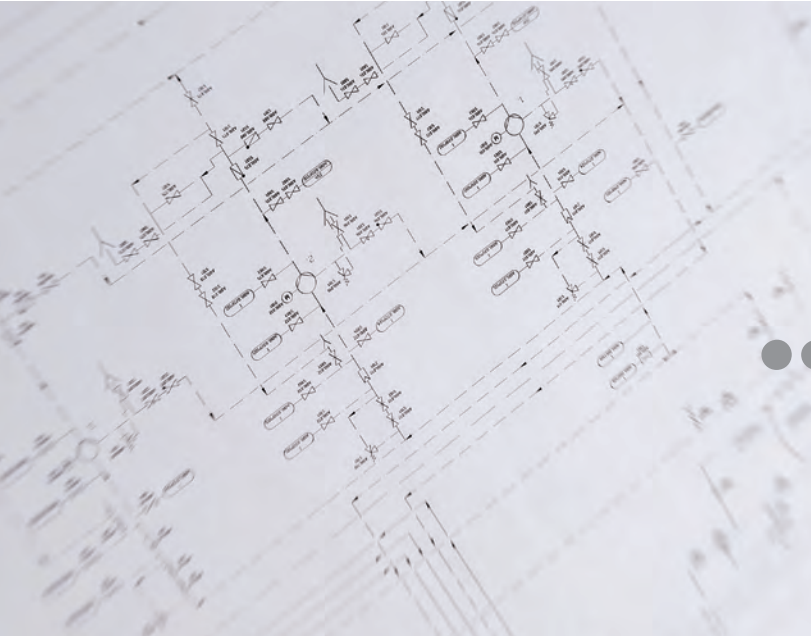

When it comes to plant labelling, our business approach also includes the documentation of our work and your plant. If desired, we can work with our in-house CAD department to prepare your identification System for Power Stations (KKS) according to the latest revision. Complete and current documentation give you the security you need for plant operation. By using a complete historical reproduction of changes in the plant as well as the documentation of the current situation, operational safety can be increased in accident and emergency situations.

Our employees will compare existing P&IDs with the current state (as-built-check) in the plant. This way, missing components can be supplemented, components that have been dismantled (e.g. as a result of renovation) can be removed and missing data can be gathered for your database. The documentation then depicts the actual condition of your plant and, using the revised P&IDs, we can assign both the quantity structures and texts (in coordination with the client) for your labelling. Our highly-qualified CAD department will then deliver the plans to you in file format; the desired attributes and digital information from AutoCAD P&ID are included.

#### **We offer the following services:**

- On-site inventory audit (as-built-check) including demand assessment
- P&ID preparation that considers the relevant standards and laws
- Determining quantity structures and batch sizes for the different sign variants
- Preparing specifications for the labelling
- Assigning and coding the equipment according to identification Systems for Power Stations (KKS) and plant labelling systems
- Preparing text and sign lists, including colour coding
- Plotting / printing the plans



### Piping and Instrumentation Diagrams (in accordance with DIN EN ISO 10628)

The Piping and Instrumentation Diagram is used to display a plant's technical equipment. The plans show the structure and function of process plants and are part of the complete technical documentation that is necessary for the planning, construction, on-site installation, administration, commissioning, operation, maintenance and decommissioning of a plant. They also aid in the exchange of information between those involved in the development, construction, on-site installation, operation and maintenance of process plants.

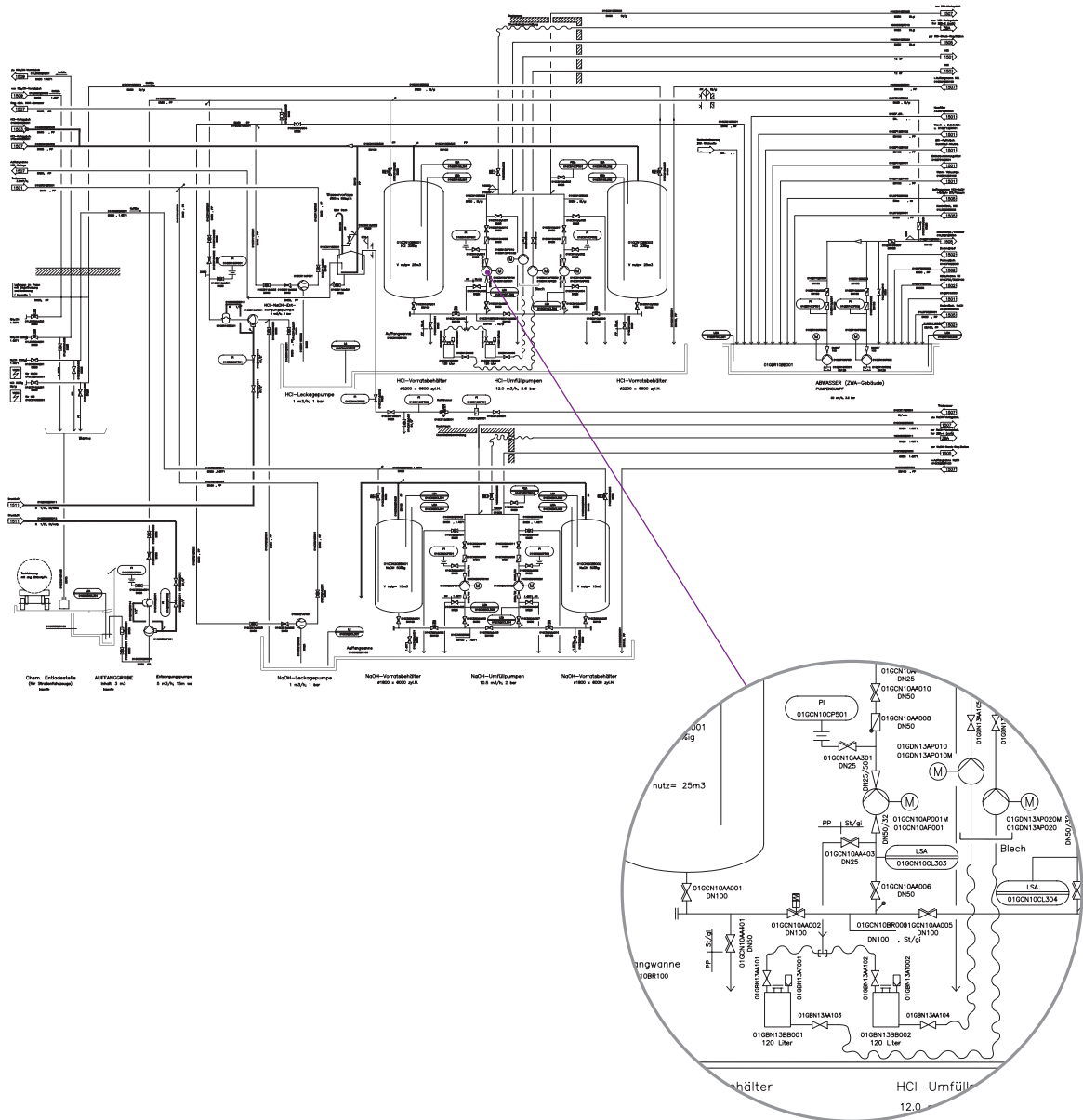

**Pipe layout diagram**

A pipe layout diagram is a simplified representation of a plant that is not to scale. The diagram mainly marks the vertical pipes and all required safety and control technology fittings, as well as shut-off devices. The pipe layout diagram can serve as the basis for pipe dimensioning. In the planning phase, it can be somewhat of a common thread for the intended material flows.

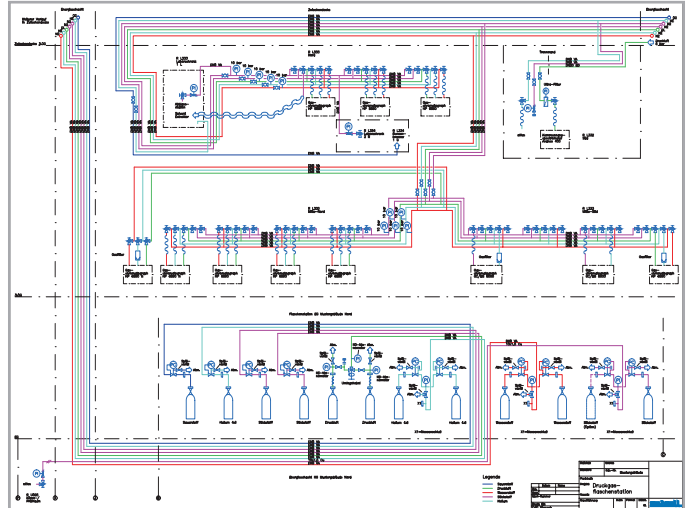

**Block diagrams**

The diagrams graphically represent the effects between numerous interacting components. A process or process plant is thus depicted in simplified form with the aid of rectangles that are connected by flow lines (e.g., substances, energies, energy carriers).

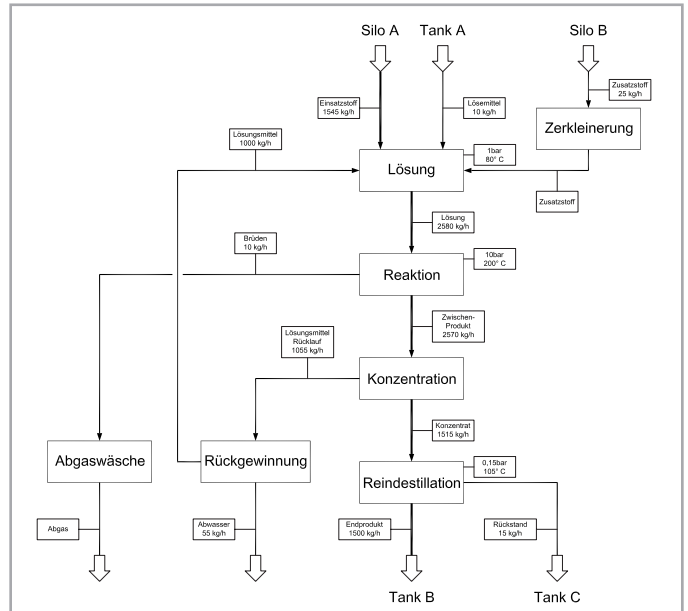

**Pipe plans**



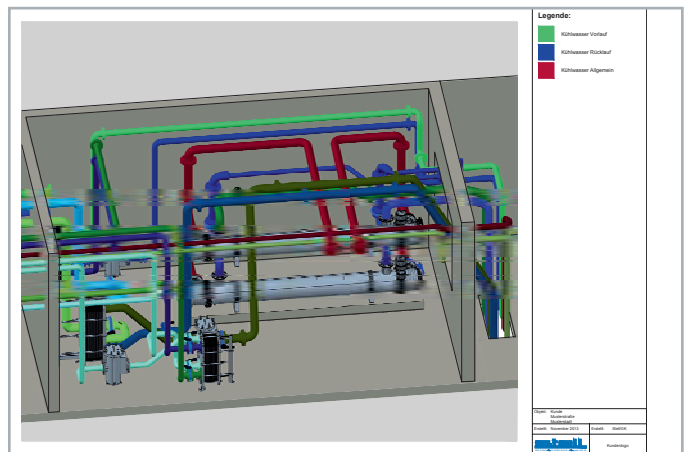





Technical drawings for the planning and construction of pipes in large chemical industry plants. Pipe plans map the course of pipes and fittings as a top view in existing installation plans.

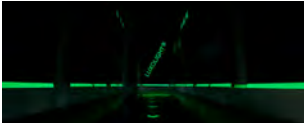

**Designs**

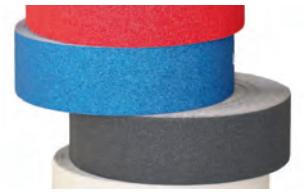
Upon completion of our work, we give you a data medium that contains the digital documentation of the plans in the desired file format. You of course also have the option to use the printing and plotter service. This includes, amongst others, multi-colour printing, standard formats up to DIN A0, photoluminescent plots, and lamination in various sizes.

# Safety Identification

	<b>Introduction</b>	<b>76</b>
	<b>Safety Way Guidance System</b>	<b>78</b>
	Luxolight® Slide-in strips , Flat profiles, Sloped profiles, Connectors	80
	End caps, Transparent escape route signs	81
	<b>Additions to Safety Way Guidance System</b>	<b>82</b>
	Transparent photoluminescent adhesive foil, Exit door handle markings	82
	Photoluminescent adhesive tape, Stairway-angles, Floor marking points	83
	<b>Safety Signs</b>	<b>84</b>
	Escape route, emergency equipment and safety action signs	85
	Fire fighting equipment signs	88
	Prohibition signs	90
	Warning signs	92
	Mandatory action signs	94
	Floor marking (antislipping)	96
	<b>Safety Markings for Obstacles and Hazardous Areas</b>	<b>97</b>
	Marking tapes	97
	<b>Floor Marking Tapes and Anti-Slip Tapes</b>	<b>98</b>
	Floor marking tapes	98
	Anti-slip tape, universal	99
	Anti-slip tape, easy clean	100
	Anti-slip tape, coarse grade	100
	<b>Knuffi® Warning and Protection Profiles</b>	<b>101</b>
	Corner protection	101
	Edge protection, Pipe protection	102
	Surface protection	103
	<b>Plans for Safety Identification</b>	<b>104</b>
	Escape plans	105
	Installation plans	106
	Fire safety regulation	106
	Designs	106
	<b>Fastening and Accessories</b>	<b>107</b>

# Introduction



Clear communication regarding hazards and rules of conduct serves as the basis for a safe working environment. Chemical parks, power stations, production plants and business premises must therefore be equipped with systematic labelling for emergency situations and day-to-day operations alike. Safety identification includes labelling of escape routes and fire protection equipment, identifying hazardous areas and how to conduct oneself in them, marking obstacles and potential hazards and putting up escape and rescue plans.

To successfully implement a safe working environment, the right planning, labelling selection and proper on-site installation is key. We offer all of this as a complete package. In our work, we focus on transmitting clear-cut messages. That's why dimensions, shape, colour, design, distance of observation and luminescence of the labels are based on prescribed standards and decades of experience. In collaborating with you, we aim to provide a sustainable solution for reliable safety identification, thus avoiding accidents, injuries and damage. Thanks to our in-house production, we can meet your requirements; what's more is that if you like, we can efficiently carry out (almost) all the relevant work for you on your premises.

## **Compulsory labelling and its implementation – regulations, standards and laws**

Occupational safety identification is globally ubiquitous, compulsory by law, and in Germany derived from the German Arbeitsschutzgesetz ("Occupational Health and Safety Act"). In the Arbeitsstättenverordnung ("Workplaces Ordinance"), labelling with signs is specifically

listed as an integral part of the legal measures. The technical rule for workplaces ASR A1.3 – "Safety and health protection labelling" – takes this measure and specifies its exact implementation in detail. This technical rule defines how our signs look in the plant, in the building or on the premises, as well as how to install them to ensure clear recognisability for all employees and visitors.

There are also international regulations and standards for safety identification. The current safety signs in Germany have already been adapted to the international standard ISO 7010. For this reason, we have grouped our signs for you in the following chapter and differentiated between the legally required signs from ASR A1.3 and the meaningful signs of the respective standard. If you would like qualified consultation, please do not hesitate to call us.

### Luxolight®

Photoluminescent labelling is considered to be particularly important, as even in the event of a power failure or smoke development, it provides a reliable means of orientation. Luxolight® is a registered trademark and represents all of our photoluminescent products. They meet high quality requirements and aid in making your working environment safe. Our Luxolight® products absorb the energy of UV rays from the ambient lighting, store it, and then emit it as yellow-green light when it's dark. Depending on the environment, varying degrees of photoluminescence may be necessary – we can offer you reliable advice about this. Most standardised Luxolight® products are delivered in B Quality from stock (DIN 67510-1:2020 ) and meet the requirements of the relevant standards. Other Qualities upon request.

The following chart describes the luminous qualities of Luxolight® as well as the specifications of ASR A3.4/7:2019 and ISO 16069:2018 at the place of use.

### Luminous qualities of Safety Signs

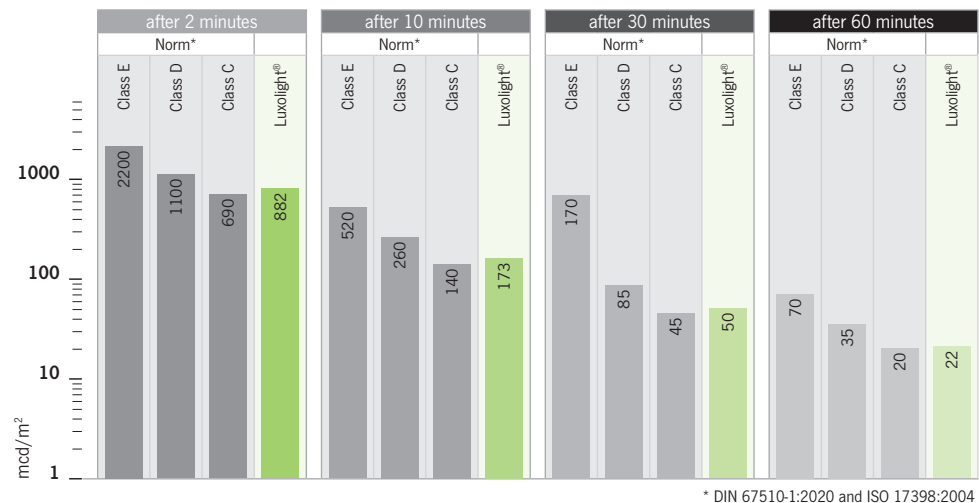

### Luminous qualities of Safety Way Guidance Systems

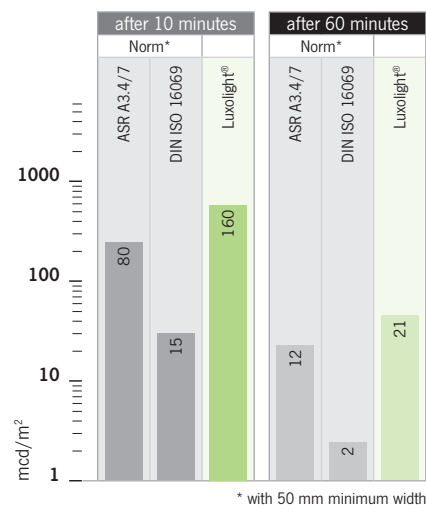

# Safety Way Guidance System



An installed safety way guidance system serves as an important protective measure should evacuation be necessary. As part of the safety concept or in consequence of a risk assessment, workplaces and places with increased risk potential must be equipped for emergency with an optical safety way guidance system that directs those affected to a safe environment or meeting points.

A safety way guidance system enables those affected to leave the premises safely and quickly – even in the event of heavy smoke and power failure. For the safety way guidance system we offer different photoluminescence qualities and installation heights that match the

on-site conditions. Thanks to the optical markings and direction indicators, all of these solutions provide for a seamless and reliable escape route. Nevertheless, they are not a substitute for the required rescue symbols that are mounted up above.

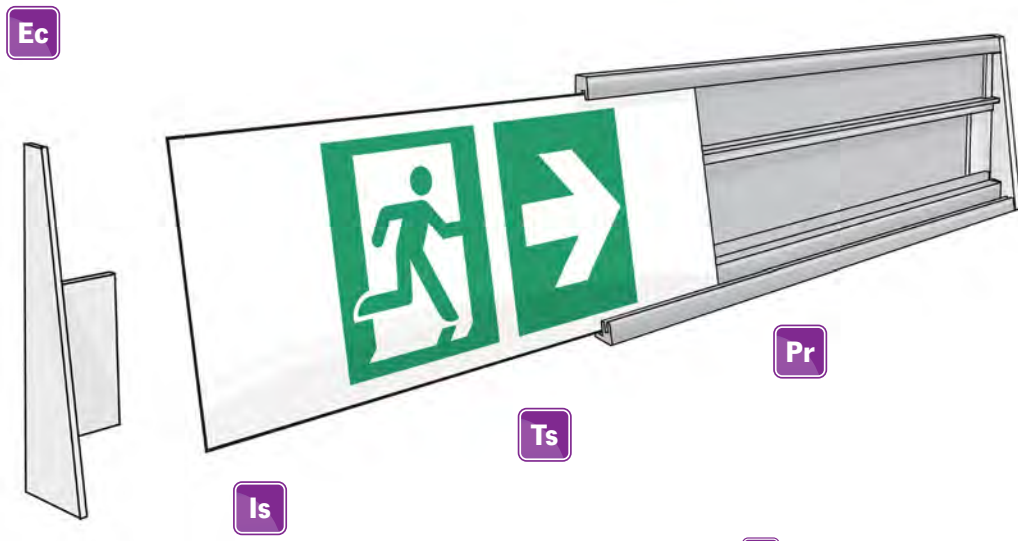

- Is** Luxolight® Inserts – page 80
- Pr** Flat- or sloped profile – page 80
- Ec** End caps – page 81
- Ts** Transparent escape route signs – page 81

**Components of the Safety Way Guidance System**

The Safety Way Guidance System consists of the inserts (**Is**), the profile (**Pr**), the transparent safety sign (**Ts**) and end caps (**Ec**). We will gladly assist you determining the right components and materials that suit your demands.

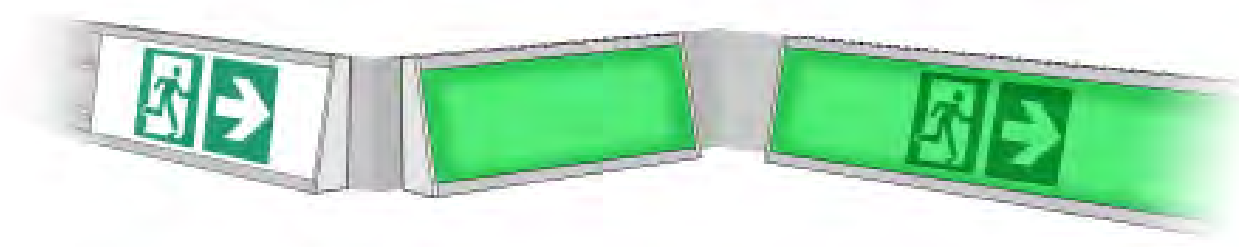



**Es** Luxolight® inserts

Material	Luminance	Quantity	Article
PVC	Luxolight®	1 piece	0025

**ASR A3.4/3**

Width x Length	Application	Order-No. Price	Article
54 x 996 mm	for profile 60 mm	<b>5033</b> € 8,00	
75 x 996 mm	for profile 80 mm	<b>5034</b> € 9,70	

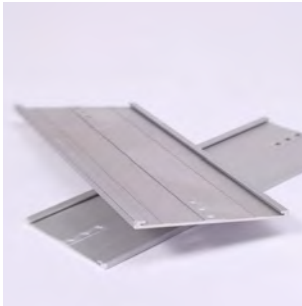

**Pr** Flat profile

Material	Quantity	Article
Chlorine free plastic <b>K</b> / Aluminium anodized <b>A</b>	1 piece	0027

**ASR A3.4/3**

Width x Length	Application	Order-No. Price	Mat.	Article
60 x 1000 mm	for inserts 54 x 996 mm	<b>5048</b> € 5,00	<b>K</b>	
		<b>5045</b> € 5,50	<b>A</b>	
80 x 1000 mm	for inserts 75 x 996 mm	<b>5049</b> € 6,50	<b>K</b>	
		<b>5046</b> € 7,00	<b>A</b>	

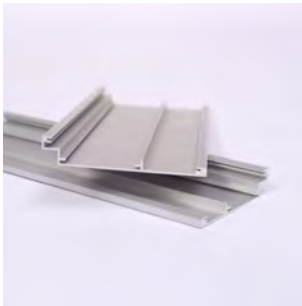

**Pr** Sloped profile

Material	Quantity	Article
Aluminium anodized	1 piece	0028

**ASR A3.4/3**

Width x Length	Application	Order-No. Price	Article
60 x 1000 mm	for inserts 54 x 996 mm	<b>5051</b> € 7,50	
80 x 1000 mm	for inserts 75 x 996 mm	<b>5052</b> € 9,00	



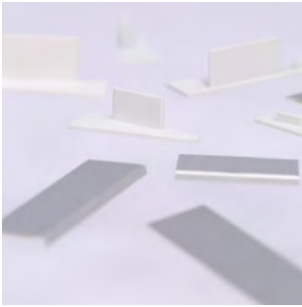

**Ec** End caps

Material	Quantity	Article
Plastic <b>K</b> / Aluminium anodized <b>A</b>	20 pieces	0026

**ASR A3.4/3**

Width x Length	Application	Order-No. Price	Mat.
18 x 54 mm	for flat profile 60 mm	<b>5036</b> € 19,90	<b>A</b>
18 x 74 mm	for flat profile 80 mm	<b>5037</b> € 28,00	<b>A</b>
12 x 60 mm	for sloped profile 60 mm, left	<b>5040</b> € 29,80	<b>K</b>
12 x 60 mm	for sloped profile 60 mm, right	<b>5041</b> € 29,80	<b>K</b>
12 x 80 mm	for sloped profile 80 mm, left	<b>5042</b> € 40,00	<b>K</b>
12 x 80 mm	for sloped profile 80 mm, right	<b>5043</b> € 40,00	<b>K</b>



**Ts** Transparent escape route signs

Material	Quantity	Article
Foil	10 pieces	0029

**ASR A1.3**

	<b>MES001</b>	<b>MES001</b>	<b>MES001</b>
96 x 48 mm	<b>Order-No.</b> 300 <b>Price</b> € 20,50	<b>302</b> € 20,50	<b>303</b> € 20,50
134 x 67 mm	<b>Order-No.</b> 6844 <b>Price</b> € 23,60	<b>6845</b> € 23,60	<b>6846</b> € 23,60
	<b>MES002</b>	<b>MES002</b>	<b>MES002</b>
96 x 48 mm	<b>Order-No.</b> 301 <b>Price</b> € 20,50	<b>304</b> € 20,50	<b>305</b> € 20,50
134 x 67 mm	<b>Order-No.</b> 6847 <b>Price</b> € 23,60	<b>6848</b> € 23,60	<b>6849</b> € 23,60

# Additions to Safety Way Guidance System

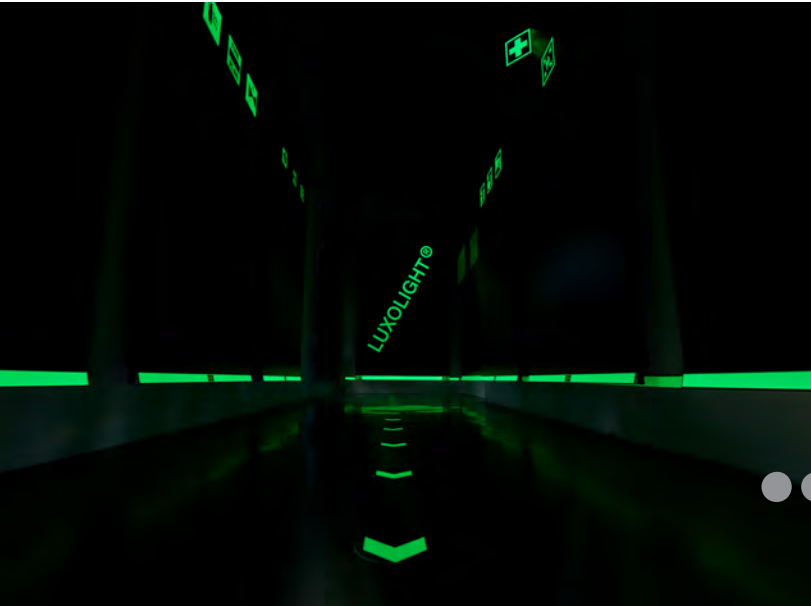

You can supplement your individual safety way guidance system with other useful components. Should circumstances at your site suggest that a safety way guidance system may not be sufficient enough on its own to ensure a path to safety as quickly and simply as possible, the following products are tried and tested completions that are worth considering.



## Transparent photoluminescent adhesive foil

Material	Luminance	Quantity	Article
Foil	Luxolight®	1 piece	0035
<i>Width x Height</i>	<i>Application</i>	<b>Order-No.</b>	<b>5071</b>
60 x 996 mm	for direct adhesion	Price	€ 11,30
80 x 996 mm	for direct adhesion	<b>Order-No.</b>	<b>5072</b>
		Price	€ 14,90



## Exit door handle marking

Material	Luminance	Quantity	Article
Foil	Luxolight®	1 piece	0037
<i>Width x Height</i>	<i>Design</i>	<b>Order-No.</b>	<b>336</b>
80 x 200 mm	with direction arrow left	Price	€ 5,20
80 x 200 mm	with direction arrow right	<b>Order-No.</b>	<b>337</b>
		Price	€ 5,20



### Stairway angles

Material	Luminance	Quantity	Article
Aluminium	Luxolight® <span style="color: green;">■</span>	1 piece	0036

Width x Length	Application	Order-No.	Price
35 x 200 mm	for mounting on stairways	<b>333</b>	<b>€ 7,90</b>

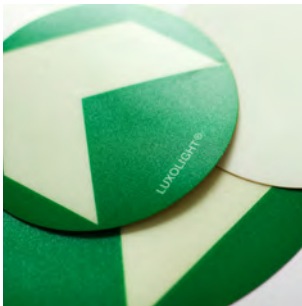

### Floor marking points, self-adhesive

Material	Luminance	Quantity	Article
Foil	Luxolight® <span style="color: green;">■</span>	1 piece	0031

Diameter	Design	Order-No.	Price
Ø 100 mm	with direction arrow	<b>5061</b>	<b>€ 2,30</b>
Ø 200 mm	with direction arrow	<b>5062</b>	<b>€ 3,60</b>
Ø 100 mm	without direction arrow	<b>5065</b>	<b>€ 2,10</b>
Ø 200 mm	without direction arrow	<b>5066</b>	<b>€ 3,90</b>

# Safety Signs



Safety signs are standardised in their message, graphical symbol and safety colours in order to ensure international understanding. Lawful safety identification includes rescue, fire protection, prohibitory, mandatory action and warning symbols.

The exact requirements for your working environment are already determined when the escape and rescue plans are drawn up during the workplace's planning phase; they are specified more precisely over the course of regular risk assessments. Our rescue and fire protection symbols are available in standard form or with a photoluminescent background. This is not the case for prohibitory, mandatory action and warning symbols; they are therefore delivered in the standard form on a white background.





## Escape route signs

Material	Luminance	Quantity	Article
PVC <b>P</b> / Foil <b>F</b>	No <input type="checkbox"/> / Luxolight® <input type="checkbox"/>	1 piece	0040

### ISO 7010



Width x Height	Mat.		-	Luxolight	-	Luxolight	-	Luxolight
300 x 150 mm	Order-No. <b>P</b>		24005	23975	24009	23979	24007	23977
	Price		€ 3,50	€ 9,90	€ 3,50	€ 9,90	€ 3,50	€ 9,90
400 x 200 mm	Order-No. <b>F</b>		23935	23945	23939	23949	23937	23947
	Price		€ 3,30	€ 9,60	€ 3,30	€ 9,60	€ 3,30	€ 9,60
300 x 150 mm	Order-No. <b>P</b>		24006	23976	24010	23980	24008	23978
	Price		€ 5,90	€ 12,40	€ 5,90	€ 12,40	€ 5,90	€ 12,40
400 x 200 mm	Order-No. <b>F</b>		23936	23946	23940	23950	23938	23948
	Price		€ 5,60	€ 12,00	€ 5,60	€ 12,00	€ 5,60	€ 12,00



Width x Height	Mat.		-	Luxolight	-	Luxolight
300 x 150 mm	Order-No. <b>P</b>		23983	23973	23981	23971
	Price		€ 3,50	€ 9,90	€ 3,50	€ 9,90
400 x 200 mm	Order-No. <b>F</b>		23933	23943	23931	23941
	Price		€ 3,30	€ 9,60	€ 3,30	€ 9,60
300 x 150 mm	Order-No. <b>P</b>		23984	23974	23982	23972
	Price		€ 5,90	€ 12,40	€ 5,90	€ 12,40
400 x 200 mm	Order-No. <b>F</b>		23934	23944	23932	23942
	Price		€ 5,60	€ 12,00	€ 5,60	€ 12,00



Width x Height	Mat.		-	Luxolight	-	Luxolight	-	Luxolight
300 x 150 mm	Order-No. <b>P</b>		23985	23995	23989	23999	23987	23997
	Price		€ 3,50	€ 9,90	€ 3,50	€ 9,90	€ 3,50	€ 9,90
400 x 200 mm	Order-No. <b>F</b>		23955	23965	23959	23969	23957	23967
	Price		€ 3,30	€ 9,60	€ 3,30	€ 9,60	€ 3,30	€ 9,60
300 x 150 mm	Order-No. <b>P</b>		23986	23996	23990	24000	23988	23998
	Price		€ 5,90	€ 12,40	€ 5,90	€ 12,40	€ 5,90	€ 12,40
400 x 200 mm	Order-No. <b>F</b>		23956	23966	23960	23970	23958	23968
	Price		€ 5,60	€ 12,00	€ 5,60	€ 12,00	€ 5,60	€ 12,00



Width x Height	Mat.		-	Luxolight	-	Luxolight
300 x 150 mm	Order-No. <b>P</b>		24003	23993	24001	23991
	Price		€ 3,50	€ 9,90	€ 3,50	€ 9,90
400 x 200 mm	Order-No. <b>F</b>		23953	23963	23951	23961
	Price		€ 3,30	€ 9,60	€ 3,30	€ 9,60
300 x 150 mm	Order-No. <b>P</b>		24004	23994	24002	23992
	Price		€ 5,90	€ 12,40	€ 5,90	€ 12,40
400 x 200 mm	Order-No. <b>F</b>		23954	23964	23952	23962
	Price		€ 5,60	€ 12,00	€ 5,60	€ 12,00



## Escape route, emergency equipment and safety action signs

<b>Material</b>	<b>Luminance</b>	<b>Quantity</b>	<b>Article</b>
PVC <b>P</b> / Foil <b>F</b>	No <input type="checkbox"/> / Luxolight® <input type="checkbox"/>	1 piece	0040

<b>ISO 7010</b>					
	-	-	E001	E002	E003

Width x Height	Mat.	-	Luxolight	-	Luxolight	-	Luxolight	-	Luxolight	-	Luxolight
150 x 150 mm	<b>Order-No.</b> <b>P</b>	<b>358</b>	<b>360</b>	<b>362</b>	<b>364</b>	<b>374</b>	<b>376</b>	<b>378</b>	<b>380</b>	<b>382</b>	<b>384</b>
	<b>Price</b>	€ 2,30	€ 5,60	€ 2,30	€ 5,60	€ 2,30	€ 5,60	€ 2,30	€ 5,60	€ 2,30	€ 5,60
200 x 200 mm	<b>Order-No.</b> <b>F</b>	<b>10084</b>	<b>10091</b>	<b>10093</b>	<b>10095</b>	<b>10107</b>	<b>10111</b>	<b>10113</b>	<b>10115</b>	<b>10117</b>	<b>10120</b>
	<b>Price</b>	€ 2,10	€ 4,30	€ 2,10	€ 4,30	€ 2,10	€ 4,30	€ 2,10	€ 4,30	€ 2,10	€ 4,30
200 x 200 mm	<b>Order-No.</b> <b>P</b>	<b>359</b>	<b>361</b>	<b>363</b>	<b>365</b>	<b>375</b>	<b>377</b>	<b>379</b>	<b>381</b>	<b>383</b>	<b>385</b>
	<b>Price</b>	€ 2,70	€ 7,40	€ 2,70	€ 7,40	€ 2,70	€ 7,40	€ 2,70	€ 7,40	€ 2,70	€ 7,40
200 x 200 mm	<b>Order-No.</b> <b>F</b>	<b>10090</b>	<b>10092</b>	<b>10094</b>	<b>10096</b>	<b>10108</b>	<b>10112</b>	<b>10114</b>	<b>10116</b>	<b>10118</b>	<b>10121</b>
	<b>Price</b>	€ 2,50	€ 7,10	€ 2,50	€ 7,10	€ 2,50	€ 7,10	€ 2,50	€ 7,10	€ 2,50	€ 7,10

E004	E007	E008	E009	E010

Width x Height	Mat.	-	Luxolight	-	Luxolight	-	Luxolight	-	Luxolight	-	Luxolight
150 x 150 mm	<b>Order-No.</b> <b>P</b>	<b>386</b>	<b>388</b>	<b>390</b>	<b>393</b>	<b>396</b>	<b>398</b>	<b>400</b>	<b>402</b>	<b>404</b>	<b>406</b>
	<b>Price</b>	€ 2,30	€ 5,60	€ 2,30	€ 5,60	€ 2,30	€ 5,60	€ 2,30	€ 5,60	€ 2,30	€ 5,60
200 x 200 mm	<b>Order-No.</b> <b>F</b>	<b>10123</b>	<b>10125</b>	<b>10128</b>	<b>10131</b>	<b>10134</b>	<b>10136</b>	<b>10138</b>	<b>10140</b>	<b>10142</b>	<b>10144</b>
	<b>Price</b>	€ 2,10	€ 5,40	€ 2,10	€ 5,40	€ 2,10	€ 5,40	€ 2,10	€ 5,40	€ 2,10	€ 5,40
200 x 200 mm	<b>Order-No.</b> <b>P</b>	<b>387</b>	<b>389</b>	<b>391</b>	<b>394</b>	<b>397</b>	<b>399</b>	<b>401</b>	<b>403</b>	<b>405</b>	<b>407</b>
	<b>Price</b>	€ 2,70	€ 7,40	€ 2,70	€ 7,40	€ 2,70	€ 7,40	€ 2,70	€ 7,40	€ 2,70	€ 7,40
200 x 200 mm	<b>Order-No.</b> <b>F</b>	<b>10124</b>	<b>10126</b>	<b>10129</b>	<b>10132</b>	<b>10135</b>	<b>10137</b>	<b>10139</b>	<b>10141</b>	<b>10143</b>	<b>10145</b>
	<b>Price</b>	€ 2,50	€ 7,10	€ 2,50	€ 7,10	€ 2,50	€ 7,10	€ 2,50	€ 7,10	€ 2,50	€ 7,10
400 x 400 mm	<b>Order-No.</b> <b>P</b>	-	-	<b>392</b>	<b>395</b>	-	-	-	-	-	-
	<b>Price</b>	-	-	€ 8,90	€ 25,60	-	-	-	-	-	-
400 x 400 mm	<b>Order-No.</b> <b>F</b>	-	-	<b>10130</b>	<b>10133</b>	-	-	-	-	-	-
	<b>Price</b>	-	-	€ 8,80	€ 25,40	-	-	-	-	-	-

E011	E012	E013	E015	E016

Width x Height	Mat.	-	Luxolight	-	Luxolight	-	Luxolight	-	Luxolight	-	Luxolight
150 x 150 mm	<b>Order-No.</b> <b>P</b>	<b>408</b>	<b>410</b>	<b>412</b>	<b>414</b>	<b>416</b>	<b>418</b>	<b>37441</b>	<b>37443</b>	<b>420</b>	<b>422</b>
	<b>Price</b>	€ 2,30	€ 5,60	€ 2,30	€ 5,60	€ 2,30	€ 5,60	€ 2,30	€ 5,60	€ 2,30	€ 5,60
200 x 200 mm	<b>Order-No.</b> <b>F</b>	<b>10146</b>	<b>10148</b>	<b>10150</b>	<b>10152</b>	<b>10154</b>	<b>10157</b>	<b>37437</b>	<b>37439</b>	<b>10159</b>	<b>10161</b>
	<b>Price</b>	€ 2,10	€ 5,40	€ 2,10	€ 5,40	€ 2,10	€ 5,40	€ 2,10	€ 5,40	€ 2,10	€ 5,40
200 x 200 mm	<b>Order-No.</b> <b>P</b>	<b>409</b>	<b>411</b>	<b>413</b>	<b>415</b>	<b>417</b>	<b>419</b>	<b>37442</b>	<b>37444</b>	<b>421</b>	<b>423</b>
	<b>Price</b>	€ 2,70	€ 7,40	€ 2,70	€ 7,40	€ 2,70	€ 7,40	€ 2,70	€ 7,40	€ 2,70	€ 7,40
200 x 200 mm	<b>Order-No.</b> <b>F</b>	<b>10147</b>	<b>10149</b>	<b>10151</b>	<b>10153</b>	<b>10155</b>	<b>10158</b>	<b>37438</b>	<b>37440</b>	<b>10160</b>	<b>10162</b>
	<b>Price</b>	€ 2,50	€ 7,10	€ 2,50	€ 7,10	€ 2,50	€ 7,10	€ 2,50	€ 7,10	€ 2,50	€ 7,10

E017	E018	E019	D-E019	WSE001

Width x Height	Mat.	-	Luxolight	-	Luxolight	-	Luxolight	-	Luxolight	-	Luxolight
150 x 150 mm	<b>Order-No.</b> <b>P</b>	<b>424</b>	<b>426</b>	<b>428</b>	<b>430</b>	<b>432</b>	<b>434</b>	<b>366</b>	<b>368</b>	<b>370</b>	<b>372</b>
	<b>Price</b>	€ 2,30	€ 5,60	€ 2,30	€ 5,60	€ 2,30	€ 5,60	€ 2,30	€ 5,60	€ 2,30	€ 5,60
200 x 200 mm	<b>Order-No.</b> <b>F</b>	<b>10163</b>	<b>10167</b>	<b>10169</b>	<b>10171</b>	<b>10173</b>	<b>10175</b>	<b>10098</b>	<b>10101</b>	<b>10103</b>	<b>10105</b>
	<b>Price</b>	€ 2,10	€ 5,40	€ 2,10	€ 5,40	€ 2,10	€ 5,40	€ 2,10	€ 5,40	€ 2,10	€ 5,40
200 x 200 mm	<b>Order-No.</b> <b>P</b>	<b>425</b>	<b>427</b>	<b>429</b>	<b>431</b>	<b>433</b>	<b>435</b>	<b>367</b>	<b>369</b>	<b>371</b>	<b>373</b>
	<b>Price</b>	€ 2,70	€ 7,40	€ 2,70	€ 7,40	€ 2,70	€ 7,40	€ 2,70	€ 7,40	€ 2,70	€ 7,40
200 x 200 mm	<b>Order-No.</b> <b>F</b>	<b>10166</b>	<b>10168</b>	<b>10170</b>	<b>10172</b>	<b>10174</b>	<b>10176</b>	<b>10099</b>	<b>10102</b>	<b>10104</b>	<b>10106</b>
	<b>Price</b>	€ 2,50	€ 7,10	€ 2,50	€ 7,10	€ 2,50	€ 7,10	€ 2,50	€ 7,10	€ 2,50	€ 7,10

											
		E020		E021		E022		E023		E024	
Width x Height	Mat.	-	Luxolight	-	Luxolight	-	Luxolight	-	Luxolight	-	Luxolight
150 x 150 mm	Order-No. <b>P</b>	37449	37451	37457	37459	37465	37467	37473	37475	37481	37483
	Price	€ 2,30	€ 5,60	€ 2,30	€ 5,60	€ 2,30	€ 5,60	€ 2,30	€ 5,60	€ 2,30	€ 5,60
150 x 150 mm	Order-No. <b>F</b>	37445	37447	37453	37455	37461	37463	37469	37471	37477	37479
	Price	€ 2,10	€ 5,40	€ 2,10	€ 5,40	€ 2,10	€ 5,40	€ 2,10	€ 5,40	€ 2,10	€ 5,40
200 x 200 mm	Order-No. <b>P</b>	37450	37452	37458	37460	37466	37468	37474	37476	37482	37484
	Price	€ 2,70	€ 7,40	€ 2,70	€ 7,40	€ 2,70	€ 7,40	€ 2,70	€ 7,40	€ 2,70	€ 7,40
200 x 200 mm	Order-No. <b>F</b>	37446	37448	37454	37456	37462	37464	37470	37472	37478	37480
	Price	€ 2,50	€ 7,10	€ 2,50	€ 7,10	€ 2,50	€ 7,10	€ 2,50	€ 7,10	€ 2,50	€ 5,70

											
		E025		E057		E058		E059		E060	
Width x Height	Mat.	-	Luxolight	-	Luxolight	-	Luxolight	-	Luxolight	-	Luxolight
150 x 150 mm	Order-No. <b>P</b>	37489	37491	37497	37499	37505	37507	37513	37515	37521	37523
	Price	€ 2,30	€ 5,60	€ 2,30	€ 5,60	€ 2,30	€ 5,60	€ 2,30	€ 5,60	€ 2,30	€ 5,60
150 x 150 mm	Order-No. <b>F</b>	37485	37487	37493	37495	37501	37503	37509	37511	37517	37519
	Price	€ 2,10	€ 5,40	€ 2,10	€ 5,40	€ 2,10	€ 5,40	€ 2,10	€ 5,40	€ 2,10	€ 5,40
200 x 200 mm	Order-No. <b>P</b>	37490	37492	37498	37500	37506	37508	37514	37516	37522	37524
	Price	€ 2,70	€ 7,40	€ 2,70	€ 7,40	€ 2,70	€ 7,40	€ 2,70	€ 7,40	€ 2,70	€ 7,40
200 x 200 mm	Order-No. <b>F</b>	37486	37488	37494	37496	37502	37504	37510	37512	37518	37520
	Price	€ 2,50	€ 7,10	€ 2,50	€ 7,10	€ 2,50	€ 7,10	€ 2,50	€ 7,10	€ 2,50	€ 7,10



## Fire fighting equipment signs

Material	Luminance	Quantity	Article
PVC <b>P</b> / Foil <b>F</b>	No <input type="checkbox"/> / Luxolight® <input type="checkbox"/>	1 piece	0046

		ISO 7010		F001		F002		F003			
Width x Height	Mat.	-	Luxolight	-	Luxolight	-	Luxolight	-	Luxolight		
150 x 150 mm	Order-No. <b>P</b>	2577	2579	5025	5027	2581	2583	2585	2587	2589	2591
	Price	€ 2,30	€ 5,60	€ 2,30	€ 5,60	€ 2,30	€ 5,60	€ 2,30	€ 5,60	€ 2,30	€ 5,60
200 x 200 mm	Order-No. <b>F</b>	10178	10180	10182	10184	10186	10188	10191	10190	10195	10197
	Price	€ 2,10	€ 5,40	€ 2,10	€ 5,40	€ 2,10	€ 5,40	€ 2,10	€ 5,40	€ 2,10	€ 5,40
150 x 150 mm	Order-No. <b>P</b>	2578	2580	5026	5028	2582	2584	2586	2588	2590	2592
	Price	€ 2,70	€ 7,40	€ 2,70	€ 7,40	€ 2,70	€ 7,40	€ 2,70	€ 7,40	€ 2,70	€ 7,40
200 x 200 mm	Order-No. <b>F</b>	10179	10181	10183	10185	10187	10189	10192	10194	10196	10198
	Price	€ 2,50	€ 7,10	€ 2,50	€ 7,10	€ 2,50	€ 7,10	€ 2,50	€ 7,10	€ 2,50	€ 7,10

		F004		F005		F006		F007		F016	
Width x Height	Mat.	-	Luxolight	-	Luxolight	-	Luxolight	-	Luxolight	-	Luxolight
150 x 150 mm	Order-No. <b>P</b>	2593	2595	2597	2599	2601	2603	37529	37531	37537	37539
	Price	€ 2,30	€ 5,60	€ 2,30	€ 5,60	€ 2,30	€ 5,60	€ 2,30	€ 5,60	€ 2,30	€ 5,60
200 x 200 mm	Order-No. <b>F</b>	10199	10201	10204	10206	10208	10210	37525	37527	37533	37535
	Price	€ 2,10	€ 5,40	€ 2,10	€ 5,40	€ 2,10	€ 5,40	€ 2,10	€ 5,40	€ 2,10	€ 5,40
150 x 150 mm	Order-No. <b>P</b>	2594	2596	2598	2600	2602	2604	37530	37532	37538	37540
	Price	€ 2,70	€ 7,40	€ 2,70	€ 7,40	€ 2,70	€ 7,40	€ 2,70	€ 7,40	€ 2,70	€ 7,40
200 x 200 mm	Order-No. <b>F</b>	10200	10202	10205	10207	10209	10211	37526	37528	37534	37536
	Price	€ 2,50	€ 7,10	€ 2,50	€ 7,10	€ 2,50	€ 7,10	€ 2,50	€ 7,10	€ 2,50	€ 7,10

























### Prohibition signs

Material		Quantity	Article
PVC		1 piece	0049
<b>ISO 7010</b>			
<i>Width x Height</i>			
150 x 150 mm	<b>Order-No.</b> 2756 <b>Price</b> € 2,40	<b>2760</b> € 2,40	<b>2762</b> € 2,40
200 x 200 mm	<b>Order-No.</b> 2757 <b>Price</b> € 2,80	<b>2761</b> € 2,80	<b>2765</b> € 2,80
<i>Width x Height</i>			
150 x 150 mm	<b>Order-No.</b> 2766 <b>Price</b> € 2,40	<b>2770</b> € 2,40	<b>2772</b> € 2,40
200 x 200 mm	<b>Order-No.</b> 2767 <b>Price</b> € 2,80	<b>2771</b> € 2,80	<b>2775</b> € 2,80
<i>Width x Height</i>			
150 x 150 mm	<b>Order-No.</b> 2776 <b>Price</b> € 2,40	<b>2780</b> € 2,40	<b>2782</b> € 2,40
200 x 200 mm	<b>Order-No.</b> 2777 <b>Price</b> € 2,80	<b>2781</b> € 2,80	<b>2783</b> € 2,80
<i>Width x Height</i>			
150 x 150 mm	<b>Order-No.</b> 2778 <b>Price</b> € 2,40	<b>2788</b> € 2,40	<b>2792</b> € 2,40
200 x 200 mm	<b>Order-No.</b> 2779 <b>Price</b> € 2,80	<b>2789</b> € 2,80	<b>2793</b> € 2,80
<i>Width x Height</i>			
150 x 150 mm	<b>Order-No.</b> 2786 <b>Price</b> € 2,40	<b>2790</b> € 2,40	<b>2792</b> € 2,40
200 x 200 mm	<b>Order-No.</b> 2787 <b>Price</b> € 2,80	<b>2791</b> € 2,80	<b>2795</b> € 2,80
<i>Width x Height</i>			
150 x 150 mm	<b>Order-No.</b> 2788 <b>Price</b> € 2,40	<b>2798</b> € 2,40	<b>2802</b> € 2,40
200 x 200 mm	<b>Order-No.</b> 2789 <b>Price</b> € 2,80	<b>2799</b> € 2,80	<b>2803</b> € 2,80
<i>Width x Height</i>			
150 x 150 mm	<b>Order-No.</b> 2796 <b>Price</b> € 2,40	<b>2800</b> € 2,40	<b>2804</b> € 2,40
200 x 200 mm	<b>Order-No.</b> 2797 <b>Price</b> € 2,80	<b>2801</b> € 2,80	<b>2805</b> € 2,80
<i>Width x Height</i>			
150 x 150 mm	<b>Order-No.</b> 2796 <b>Price</b> € 2,40	<b>2798</b> € 2,40	<b>2800</b> € 2,40
200 x 200 mm	<b>Order-No.</b> 2797 <b>Price</b> € 2,80	<b>2799</b> € 2,80	<b>2801</b> € 2,80
<i>Width x Height</i>			
150 x 150 mm	<b>Order-No.</b> 2796 <b>Price</b> € 2,40	<b>2798</b> € 2,40	<b>2800</b> € 2,40
200 x 200 mm	<b>Order-No.</b> 2797 <b>Price</b> € 2,80	<b>2799</b> € 2,80	<b>2801</b> € 2,80
<i>Width x Height</i>			
150 x 150 mm	<b>Order-No.</b> 2796 <b>Price</b> € 2,40	<b>2798</b> € 2,40	<b>2800</b> € 2,40
200 x 200 mm	<b>Order-No.</b> 2797 <b>Price</b> € 2,80	<b>2799</b> € 2,80	<b>2801</b> € 2,80

							
		P028	P029	P030	P031	P032	
<i>Width x Height</i>		<b>Order-No.</b>	<b>2806</b>	<b>2808</b>	<b>2810</b>	<b>2812</b>	<b>2814</b>
150 x 150 mm		Price	€ 2,40	€ 2,40	€ 2,40	€ 2,40	€ 2,40
		<b>Order-No.</b>	<b>2807</b>	<b>2809</b>	<b>2811</b>	<b>2813</b>	<b>2815</b>
200 x 200 mm		Price	€ 2,80	€ 2,80	€ 2,80	€ 2,80	€ 2,80

							
		P033	P034	P035	P039	P041	
<i>Width x Height</i>		<b>Order-No.</b>	<b>2816</b>	<b>2818</b>	<b>37543</b>	<b>37545</b>	<b>37547</b>
150 x 150 mm		Price	€ 2,40	€ 2,40	€ 2,40	€ 2,40	€ 2,40
		<b>Order-No.</b>	<b>2817</b>	<b>2819</b>	<b>37544</b>	<b>37546</b>	<b>37548</b>
200 x 200 mm		Price	€ 2,80	€ 2,80	€ 2,80	€ 2,80	€ 2,80





							
		P042	P043	P044	P049	P052	
<i>Width x Height</i>		<b>Order-No.</b>	<b>37549</b>	<b>37551</b>	<b>37553</b>	<b>37555</b>	<b>37557</b>
150 x 150 mm		Price	€ 2,40	€ 2,40	€ 2,40	€ 2,40	€ 2,40
		<b>Order-No.</b>	<b>37550</b>	<b>37552</b>	<b>37554</b>	<b>37556</b>	<b>37558</b>
200 x 200 mm		Price	€ 2,80	€ 2,80	€ 2,80	€ 2,80	€ 2,80





						
		WSP001	D-P006	D-P016	D-P022	
<i>Width x Height</i>		<b>Order-No.</b>	<b>2826</b>	<b>2820</b>	<b>2822</b>	<b>2824</b>
150 x 150 mm		Price	€ 2,40	€ 2,40	€ 2,40	€ 2,40
		<b>Order-No.</b>	<b>2827</b>	<b>2821</b>	<b>2823</b>	<b>2825</b>
200 x 200 mm		Price	€ 2,80	€ 2,80	€ 2,80	€ 2,80







## Warning signs

Material		Quantity	Article
PVC		1 piece	0051
<b>ISO 7010</b>			
<b>Width x Height</b>		<b>W001</b>	<b>W002</b>
150 x 150 mm	<b>Order-No.</b> Price	2940 € 2,40	2942 € 2,40
200 x 200 mm	<b>Order-No.</b> Price	2941 € 2,80	2943 € 2,80
<b>Width x Height</b>		<b>W006</b>	<b>W007</b>
150 x 150 mm	<b>Order-No.</b> Price	2950 € 2,40	2952 € 2,40
200 x 200 mm	<b>Order-No.</b> Price	2951 € 2,80	2953 € 2,80
<b>Width x Height</b>		<b>W011</b>	<b>W012</b>
150 x 150 mm	<b>Order-No.</b> Price	2960 € 2,40	2962 € 2,40
200 x 200 mm	<b>Order-No.</b> Price	2961 € 2,80	2963 € 2,80
<b>Width x Height</b>		<b>W016</b>	<b>W017</b>
150 x 150 mm	<b>Order-No.</b> Price	2970 € 2,40	2972 € 2,40
200 x 200 mm	<b>Order-No.</b> Price	2971 € 2,80	2973 € 2,80
<b>Width x Height</b>		<b>W021</b>	<b>D-W021</b>
150 x 150 mm	<b>Order-No.</b> Price	2980 € 2,40	2998 € 2,40
200 x 200 mm	<b>Order-No.</b> Price	2981 € 2,80	2999 € 2,80
<b>Width x Height</b>		<b>W022</b>	<b>D-W022</b>
150 x 150 mm	<b>Order-No.</b> Price	2982 € 2,40	3000 € 2,40
200 x 200 mm	<b>Order-No.</b> Price	2983 € 2,80	3001 € 2,80
<b>Width x Height</b>		<b>W023</b>	<b>W023</b>
150 x 150 mm	<b>Order-No.</b> Price	2984 € 2,40	2984 € 2,40
200 x 200 mm	<b>Order-No.</b> Price	2985 € 2,80	2985 € 2,80





















						
		W024	W025	W026	W027	W028
<i>Width x Height</i>		<b>2986</b>	<b>2988</b>	<b>2990</b>	<b>2992</b>	<b>2994</b>
150 x 150 mm	<b>Order-No.</b>	€ 2,40	€ 2,40	€ 2,40	€ 2,40	€ 2,40
	<b>Price</b>					
200 x 200 mm	<b>Order-No.</b>	<b>2987</b>	<b>2989</b>	<b>2991</b>	<b>2993</b>	<b>2995</b>
	<b>Price</b>	€ 2,80	€ 2,80	€ 2,80	€ 2,80	€ 2,80

						
		W029	W030	W033	W035	W037
<i>Width x Height</i>		<b>2996</b>	<b>37559</b>	<b>37561</b>	<b>37563</b>	<b>37565</b>
150 x 150 mm	<b>Order-No.</b>	€ 2,40	€ 2,40	€ 2,40	€ 2,40	€ 2,40
	<b>Price</b>					
200 x 200 mm	<b>Order-No.</b>	<b>2997</b>	<b>37560</b>	<b>37562</b>	<b>37564</b>	<b>37566</b>
	<b>Price</b>	€ 2,80	€ 2,80	€ 2,80	€ 2,80	€ 2,80

					
		W038	W041	W042	W055
<i>Width x Height</i>		<b>37567</b>	<b>37569</b>	<b>37571</b>	<b>37573</b>
150 x 150 mm	<b>Order-No.</b>	€ 2,40	€ 2,40	€ 2,40	€ 2,40
	<b>Price</b>				
200 x 200 mm	<b>Order-No.</b>	<b>37568</b>	<b>37570</b>	<b>37572</b>	<b>37574</b>
	<b>Price</b>	€ 2,80	€ 2,80	€ 2,80	€ 2,80



### Mandatory action signs

Material		Quantity	Article			
PVC		1 piece	0053			
<b>ISO 7010</b>						
<i>Width x Height</i>						
		M001	M002	M003	M004	M005
150 x 150 mm	<b>Order-No.</b> Price	<b>3124</b> € 2,40	<b>3126</b> € 2,40	<b>3128</b> € 2,40	<b>3130</b> € 2,40	<b>3132</b> € 2,40
200 x 200 mm	<b>Order-No.</b> Price	<b>3125</b> € 2,80	<b>3127</b> € 2,80	<b>3129</b> € 2,80	<b>3131</b> € 2,80	<b>3133</b> € 2,80
<i>Width x Height</i>						
		M006	M007	M008	M009	M010
150 x 150 mm	<b>Order-No.</b> Price	<b>3134</b> € 2,40	<b>3136</b> € 2,40	<b>3138</b> € 2,40	<b>3140</b> € 2,40	<b>3142</b> € 2,40
200 x 200 mm	<b>Order-No.</b> Price	<b>3135</b> € 2,80	<b>3137</b> € 2,80	<b>3139</b> € 2,80	<b>3141</b> € 2,80	<b>3143</b> € 2,80
<i>Width x Height</i>						
		M011	M012	M013	M014	M015
150 x 150 mm	<b>Order-No.</b> Price	<b>3144</b> € 2,40	<b>3146</b> € 2,40	<b>3148</b> € 2,40	<b>3150</b> € 2,40	<b>3152</b> € 2,40
200 x 200 mm	<b>Order-No.</b> Price	<b>3145</b> € 2,80	<b>3147</b> € 2,80	<b>3149</b> € 2,80	<b>3151</b> € 2,80	<b>3153</b> € 2,80
<i>Width x Height</i>						
		M016	M017	M018	M019	M020
150 x 150 mm	<b>Order-No.</b> Price	<b>3154</b> € 2,40	<b>3156</b> € 2,40	<b>3158</b> € 2,40	<b>3160</b> € 2,40	<b>3162</b> € 2,40
200 x 200 mm	<b>Order-No.</b> Price	<b>3155</b> € 2,80	<b>3157</b> € 2,80	<b>3159</b> € 2,80	<b>3161</b> € 2,80	<b>3163</b> € 2,80

		M021	M022	M023	M024	M025
Width x Height						
150 x 150 mm	<b>Order-No.</b>	<b>3164</b>	<b>3166</b>	<b>3168</b>	<b>3170</b>	<b>3172</b>
	Price	€ 2,40	€ 2,40	€ 2,40	€ 2,40	€ 2,40
200 x 200 mm	<b>Order-No.</b>	<b>3165</b>	<b>3167</b>	<b>3169</b>	<b>3171</b>	<b>3173</b>
	Price	€ 2,80	€ 2,80	€ 2,80	€ 2,80	€ 2,80

		M026	M027	M028	M029	M030
Width x Height						
150 x 150 mm	<b>Order-No.</b>	<b>3174</b>	<b>37575</b>	<b>37591</b>	<b>37593</b>	<b>37577</b>
	Price	€ 2,40	€ 2,40	€ 2,40	€ 2,40	€ 2,40
200 x 200 mm	<b>Order-No.</b>	<b>3175</b>	<b>37576</b>	<b>37592</b>	<b>37594</b>	<b>37578</b>
	Price	€ 2,80	€ 2,80	€ 2,80	€ 2,80	€ 2,80

		M031	M032	M046	M047	M048
Width x Height						
150 x 150 mm	<b>Order-No.</b>	<b>37579</b>	<b>37581</b>	<b>37583</b>	<b>37585</b>	<b>37587</b>
	Price	€ 2,40	€ 2,40	€ 2,40	€ 2,40	€ 2,40
200 x 200 mm	<b>Order-No.</b>	<b>37580</b>	<b>37582</b>	<b>37584</b>	<b>37586</b>	<b>37588</b>
	Price	€ 2,80	€ 2,80	€ 2,80	€ 2,80	€ 2,80

		M054	WSM001
Width x Height			
150 x 150 mm	<b>Order-No.</b>	<b>37589</b>	<b>3180</b>
	Price	€ 2,40	€ 2,40
200 x 200 mm	<b>Order-No.</b>	<b>37590</b>	<b>3181</b>
	Price	€ 2,80	€ 2,80

### Floor marking (antislipping)

In some cases, safety identification might be even more effective if placed on the ground. These self-adhesive sticker signs can be applied directly to the ground but the edges should be sealed in order to avoid premature wear. Our floor signs are slip resistant to prevent slip hazard.



Material	Slip-prevention	Quantity	Article		
Foil	R 10	1 piece	0056		
Diameter	M001	M003	M004	M008	M009
Ø 300 mm	<b>Order-No.</b> 3290 Price € 17,20	<b>Order-No.</b> 3291 Price € 17,20	<b>Order-No.</b> 3292 Price € 17,20	<b>Order-No.</b> 3293 Price € 17,20	<b>Order-No.</b> 3294 Price € 17,20
Diameter	M012	M014	M024		
Ø 300 mm	<b>Order-No.</b> 3295 Price € 17,20	<b>Order-No.</b> 3296 Price € 17,20	<b>Order-No.</b> 3297 Price € 17,20		
Diameter	P001	P002	P004	P006	P012
Ø 300 mm	<b>Order-No.</b> 3298 Price € 17,20	<b>Order-No.</b> 3299 Price € 17,20	<b>Order-No.</b> 3300 Price € 17,20	<b>Order-No.</b> 3301 Price € 17,20	<b>Order-No.</b> 3302 Price € 17,20
Diameter	P023	P024	D-P006		
Ø 300 mm	<b>Order-No.</b> 3303 Price € 17,20	<b>Order-No.</b> 3304 Price € 17,20	<b>Order-No.</b> 3289 Price € 17,20		
Side length	W001	W007	W014	W015	D-W021
300 mm	<b>Order-No.</b> 3305 Price € 17,20	<b>Order-No.</b> 3306 Price € 17,20	<b>Order-No.</b> 3307 Price € 17,20	<b>Order-No.</b> 3308 Price € 17,20	<b>Order-No.</b> 3288 Price € 17,20



# Safety Markings for Obstacles and Hazardous Areas

Whether for everyday or emergency purposes, labelling obstacles and hazardous areas is an integral part of comprehensive safety identification. A colour design is recommended for day-to-day operations, but for workplaces where no complex safety lighting is installed, a safety marking in the form of photoluminescent marking tape is preferable.



## Marking tapes

Material	Quantity	Article
Foil	1 piece	0058

Width x Length	Application	Colours	Order-No.	Price
40 mm x 25 m	permanent danger warning		<b>2746</b>	€ 37,00
40 mm x 25 m	temporary danger warning		<b>2740</b>	€ 37,00
80 mm x 25 m	permanent danger warning		<b>2747</b>	€ 66,50
80 mm x 25 m	temporary danger warning		<b>2741</b>	€ 66,50

### ISO 3864

Width x Length	Application	Colours	Order-No.	Price
40 mm x 25 m	command signal		<b>2742</b>	€ 37,00
40 mm x 25 m	safe situation		<b>2744</b>	€ 37,00
80 mm x 25 m	command signal		<b>2743</b>	€ 66,50
80 mm x 25 m	safe situation		<b>2745</b>	€ 66,50

# Floor marking and Anti-Slip tapes

The labelling of passage ways in accordance with ASR A1.8 is mandatory. What's more, due to the frequency and severity of slip accidents floor marking tapes and anti-slip floorings play an increasingly important role within safety and health systems. In the following you can find a selection of products to maintain the safety of your facility and further prevent and reduce these kind of accidents. Anti-slip floorings help to prevent slip accidents on indoor and outdoor surfaces that are slick, slippery, wet and/or soiled by oil or grease. These products might be used for labelling of entrance areas, passageways, walkways, stairs, ascents, ramps, machines, vehicles, kitchen and canteens, terraces, shelters etc.



## Floor marking tapes

Material			Quantity	Article
PVC film			1 piece	0108
Width x Length	Design	Colours		
50 mm x 33 m	black		<b>Order-No.</b> 36801	<b>Price</b> € 5,20
75 mm x 33 m			<b>Order-No.</b> 36802	<b>Price</b> € 7,80
50 mm x 33 m	yellow		<b>Order-No.</b> 36803	<b>Price</b> € 5,20
75 mm x 33 m			<b>Order-No.</b> 36804	<b>Price</b> € 7,80
50 mm x 33 m	blue		<b>Order-No.</b> 36805	<b>Price</b> € 5,20
75 mm x 33 m			<b>Order-No.</b> 36806	<b>Price</b> € 7,80
50 mm x 33 m	red		<b>Order-No.</b> 36807	<b>Price</b> € 5,20
75 mm x 33 m			<b>Order-No.</b> 36808	<b>Price</b> € 7,80
50 mm x 33 m	green		<b>Order-No.</b> 36809	<b>Price</b> € 5,20
75 mm x 33 m			<b>Order-No.</b> 36810	<b>Price</b> € 7,80
50 mm x 33 m	white		<b>Order-No.</b> 36811	<b>Price</b> € 5,20
75 mm x 33 m			<b>Order-No.</b> 36812	<b>Price</b> € 7,80
50 mm x 33 m	orange		<b>Order-No.</b> 36813	<b>Price</b> € 5,20
75 mm x 33 m			<b>Order-No.</b> 36814	<b>Price</b> € 7,80
50 mm x 33 m	black/yellow striped		<b>Order-No.</b> 36815	<b>Price</b> € 7,00
75 mm x 33 m			<b>Order-No.</b> 36816	<b>Price</b> € 10,50
50 mm x 33 m	red/white striped		<b>Order-No.</b> 36817	<b>Price</b> € 7,00
75 mm x 33 m			<b>Order-No.</b> 36818	<b>Price</b> € 10,50



## Anti-slip tape, general purpose

Material	Slip-prevention	Luminance (after 10 min.)	Quantity	Article
PVC Grit Carrying Web	R 13	No <input type="checkbox"/> / 150 mcd/m <sup>2</sup> <input type="checkbox"/>	1 piece	0108

Width x Length	Design	Colours	Order-No.	Price
50 mm x 18,3 m	black		36819	€ 44,00
75 mm x 18,3 m			36820	€ 66,00
50 mm x 18,3 m	yellow		36821	€ 44,00
75 mm x 18,3 m			36822	€ 66,00
50 mm x 18,3 m	white		36823	€ 44,00
75 mm x 18,3 m			36824	€ 66,00
50 mm x 18,3 m	grey		36825	€ 44,00
75 mm x 18,3 m			36826	€ 66,00
50 mm x 18,3 m	blue		36827	€ 44,00
75 mm x 18,3 m			36828	€ 66,00
50 mm x 18,3 m	red		36829	€ 44,00
75 mm x 18,3 m			36830	€ 66,00
50 mm x 18,3 m	green		36831	€ 44,00
75 mm x 18,3 m			36832	€ 66,00
50 mm x 18,3 m	brown		36833	€ 44,00
75 mm x 18,3 m			36834	€ 66,00
50 mm x 18,3 m	black/yellow striped		36835	€ 53,00
75 mm x 18,3 m			36836	€ 79,50
50 mm x 18,3 m	red/white striped		36837	€ 53,00
75 mm x 18,3 m			36838	€ 79,50
50 mm x 18,3 m	luminescent		36839	€ 162,00
100 mm x 18,3 m			36840	€ 324,00
50 mm x 18,3 m	black/luminescent striped		36841	€ 178,00
100 mm x 18,3 m			36842	€ 356,00
50 mm x 18,3 m	black - extra strong		36867	€ 85,00
75 mm x 18,3 m			36868	€ 127,50



### Anti-slip tape, easy clean

Material	Slip-prevention	Quantity	Article
PVC Grit Carrying Web	R 10	1 piece	0108

Width x Length	Design	Colours
50 mm x 18,3 m	black	
100 mm x 18,3 m		
50 mm x 18,3 m	yellow	
100 mm x 18,3 m		
50 mm x 18,3 m	clear	
100 mm x 18,3 m		
50 mm x 18,3 m	grey	
100 mm x 18,3 m		
50 mm x 18,3 m	blue	
100 mm x 18,3 m		
50 mm x 18,3 m	red	
100 mm x 18,3 m		
50 mm x 18,3 m	green	
100 mm x 18,3 m		
50 mm x 18,3 m	white	
100 mm x 18,3 m		
50 mm x 18,3 m	black/yellow	
100 mm x 18,3 m		

<b>Order-No.</b>	<b>36843</b>
Price	€ 52,00
<b>Order-No.</b>	<b>36844</b>
Price	€ 104,00
<b>Order-No.</b>	<b>36845</b>
Price	€ 52,00
<b>Order-No.</b>	<b>36846</b>
Price	€ 104,00
<b>Order-No.</b>	<b>36847</b>
Price	€ 52,00
<b>Order-No.</b>	<b>36848</b>
Price	€ 104,00
<b>Order-No.</b>	<b>36849</b>
Price	€ 52,00
<b>Order-No.</b>	<b>36850</b>
Price	€ 104,00
<b>Order-No.</b>	<b>36851</b>
Price	€ 52,00
<b>Order-No.</b>	<b>36852</b>
Price	€ 104,00
<b>Order-No.</b>	<b>36853</b>
Price	€ 52,00
<b>Order-No.</b>	<b>36854</b>
Price	€ 104,00
<b>Order-No.</b>	<b>36855</b>
Price	€ 52,00
<b>Order-No.</b>	<b>36856</b>
Price	€ 104,00
<b>Order-No.</b>	<b>36857</b>
Price	€ 52,00
<b>Order-No.</b>	<b>36858</b>
Price	€ 104,00
<b>Order-No.</b>	<b>36859</b>
Price	€ 62,50
<b>Order-No.</b>	<b>36860</b>
Price	€ 125,00



### Anti-slip tape, coarse grade

Material	Slip-prevention	Quantity	Article
Aluminium	R 13	1 piece	0108

Width x Length	Design	Colours
50 mm x 18,3 m	black	
100 mm x 18,3 m		
50 mm x 18,3 m	yellow	
100 mm x 18,3 m		
50 mm x 18,3 m	black/yellow striped	
100 mm x 18,3 m		
50 mm x 18,3 m	black/coarse conformable	
100 mm x 18,3 m		

<b>Order-No.</b>	<b>36861</b>
Price	€ 53,00
<b>Order-No.</b>	<b>36862</b>
Price	€ 106,00
<b>Order-No.</b>	<b>36863</b>
Price	€ 53,00
<b>Order-No.</b>	<b>36864</b>
Price	€ 106,00
<b>Order-No.</b>	<b>36865</b>
Price	€ 53,00
<b>Order-No.</b>	<b>36866</b>
Price	€ 106,00
<b>Order-No.</b>	<b>36869</b>
Price	€ 94,00
<b>Order-No.</b>	<b>36870</b>
Price	€ 188,00

# Knuffi® Warning and Protection Profiles

Warning and protection profiles effectively prevent impact injuries. Due to their striking colour in accordance with ASR A1.3, they caution you about the threat of collisions. Knuffi® products are made from flexible polyurethane foam using a patented process. They provide a visual warning through the specific colours and the material absorbs even the hardest impacts with ease.

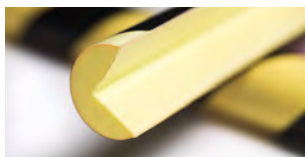

## Corner protection, self adhesive

Material	Luminance (after 10 min.)	Quantity	Article
Polyurethane foam	No <input type="checkbox"/> / 155 mcd/m <sup>2</sup> <input type="checkbox"/>	1 m / 5 m	0059

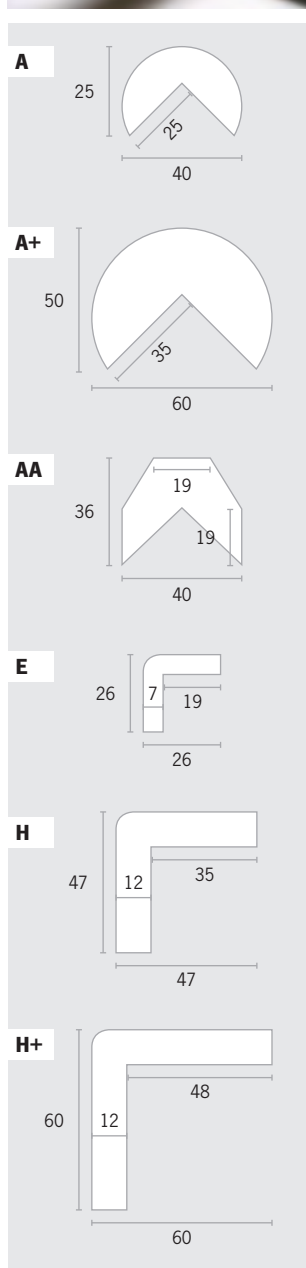

Typ	Design	Colours	Quantity		Article
			1 m	5 m	
A	black/yellow		<b>Order-No.</b> 3317 <b>Price</b> € 25,25	<b>3413</b> € 148,50	
A	red/white		<b>Order-No.</b> 3318 <b>Price</b> € 29,50	<b>3414</b> € 175,50	
A	white		<b>Order-No.</b> 3319 <b>Price</b> € 30,90	<b>3415</b> € 83,00	
A	black/daylight fluorescent		<b>Order-No.</b> 3320 <b>Price</b> € 33,50	–	
A	black/luminescent		<b>Order-No.</b> 3321 <b>Price</b> € 46,90	–	
A	black		<b>Order-No.</b> 3322 <b>Price</b> € 28,50	<b>3418</b> € 167,90	
A+	black/yellow		<b>Order-No.</b> 3323 <b>Price</b> € 54,50	–	
A+	red/white		<b>Order-No.</b> 3324 <b>Price</b> € 54,50	–	
A+	white		<b>Order-No.</b> 3325 <b>Price</b> € 54,50	–	
A+	black		<b>Order-No.</b> 3328 <b>Price</b> € 54,50	–	
AA	black/yellow		<b>Order-No.</b> 3329 <b>Price</b> € 24,30	<b>3425</b> € 143,15	
AA	red/white		<b>Order-No.</b> 3330 <b>Price</b> € 28,50	<b>3426</b> € 169,00	
AA	white		<b>Order-No.</b> 3331 <b>Price</b> € 29,90	<b>3427</b> € 176,00	
AA	black		<b>Order-No.</b> 3334 <b>Price</b> € 27,50	<b>3430</b> € 161,50	
E	black/yellow		<b>Order-No.</b> 3335 <b>Price</b> € 25,25	<b>3431</b> € 148,50	
E	red/white		<b>Order-No.</b> 3336 <b>Price</b> € 29,50	<b>3432</b> € 175,50	
E	white		<b>Order-No.</b> 3337 <b>Price</b> € 30,90	<b>3433</b> € 183,00	
E	black		<b>Order-No.</b> 3340 <b>Price</b> € 28,50	<b>3436</b> € 167,90	
H	black/yellow		<b>Order-No.</b> 3341 <b>Price</b> € 29,65	<b>3437</b> € 167,60	
H	red/white		<b>Order-No.</b> 3342 <b>Price</b> € 35,90	<b>3438</b> € 202,00	
H	white		<b>Order-No.</b> 3343 <b>Price</b> € 37,50	<b>3439</b> € 210,90	
H	black		<b>Order-No.</b> 3346 <b>Price</b> € 33,90	<b>3442</b> € 193,50	
H+	black/yellow		<b>Order-No.</b> 3347 <b>Price</b> € 49,90	–	
H+	red/white		<b>Order-No.</b> 3348 <b>Price</b> € 49,90	–	
H+	white		<b>Order-No.</b> 3349 <b>Price</b> € 49,90	–	
H+	black		<b>Order-No.</b> 3352 <b>Price</b> € 49,90	–	

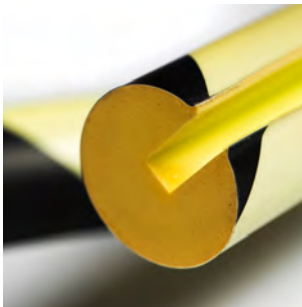

## Edge protection

Material	Luminance (after 10 min.)	Quantity	Article
Polyurethane foam	No <input type="checkbox"/> / 155 mcd/m <sup>2</sup> <input type="checkbox"/>	1 m / 5 m	0059

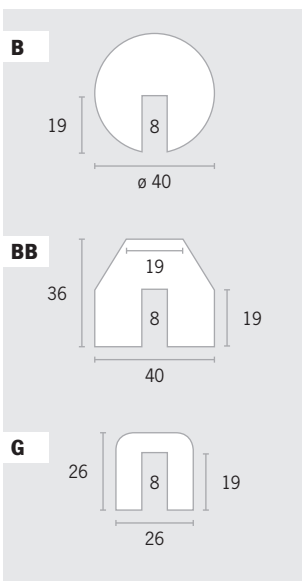

Typ	Design	Colours	Quantity	
			1 m	5 m
B	black/yellow		<b>Order-No.</b> 3359 Price € 21,45	<b>3455</b> € 119,90
B	red/white		<b>Order-No.</b> 3360 Price € 28,90	<b>3456</b> € 173,50
B	white		<b>Order-No.</b> 3361 Price € 29,95	<b>3457</b> € 180,90
B	black/daylight fluorescent		<b>Order-No.</b> 3362 Price € 32,50	–
B	black/luminescent		<b>Order-No.</b> 3363 Price € 46,90	–
B	black		<b>Order-No.</b> 3364 Price € 27,50	<b>3460</b> € 165,90
BB	black/yellow		<b>Order-No.</b> 3353 Price € 20,70	<b>3449</b> € 114,60
BB	red/white		<b>Order-No.</b> 3354 Price € 28,50	<b>3450</b> € 165,00
BB	white		<b>Order-No.</b> 3355 Price € 29,00	<b>3451</b> € 172,50
BB	black		<b>Order-No.</b> 3358 Price € 26,50	<b>3454</b> € 157,90
G	black/yellow		<b>Order-No.</b> 3365 Price € 23,65	<b>3461</b> € 126,90
G	red/white		<b>Order-No.</b> 3366 Price € 32,90	<b>3462</b> € 190,00
G	white		<b>Order-No.</b> 3367 Price € 34,00	<b>3463</b> € 198,50
G	black		<b>Order-No.</b> 3370 Price € 31,50	<b>3466</b> € 182,00

## Piping protection, self adhesive

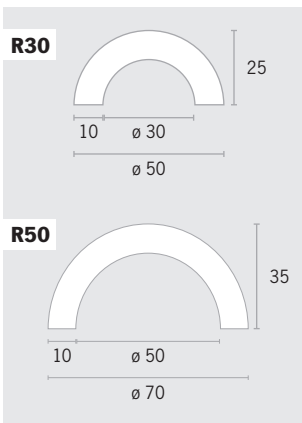

Material	Quantity	Article
Polyurethane foam	1 m / 5 m	0059

Typ	Design	Colours	Quantity	
			1 m	5 m
R30	black/yellow		<b>Order-No.</b> 3371 Price € 39,50	<b>3467</b> € 214,50
R30	red/white		<b>Order-No.</b> 3372 Price € 49,00	<b>3468</b> € 272,50
R30	white		<b>Order-No.</b> 3373 Price € 51,50	<b>3469</b> € 284,50
R30	black		<b>Order-No.</b> 3376 Price € 46,90	<b>3472</b> € 260,90
R50	black/yellow		<b>Order-No.</b> 3377 Price € 51,15	–
R50	red/white		<b>Order-No.</b> 3378 Price € 63,50	–
R50	white		<b>Order-No.</b> 3379 Price € 66,50	–
R50	black		<b>Order-No.</b> 3382 Price € 60,90	–



## Surface protection, self adhesive

Material	Luminance (after 10 min.)	Quantity	Article
Polyurethane foam	No <input type="checkbox"/> / 155 mcd/m <sup>2</sup> <input type="checkbox"/>	1 m / 5 m	0059

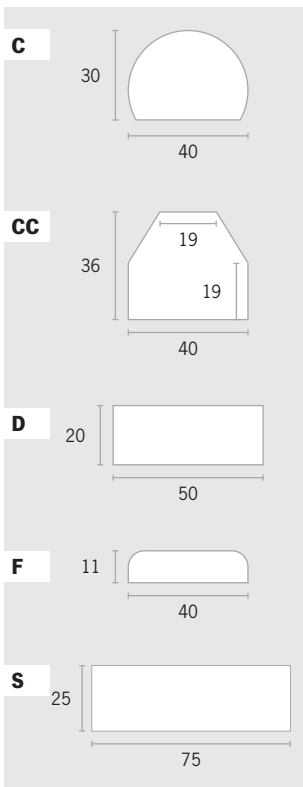

Typ	Design	Colours	Quantity	
			1 m	5 m
C	black/yellow		<b>Order-No.</b> 3407 Price € 25,85	<b>3503</b> € 151,80
C	red/white		<b>Order-No.</b> 3408 Price € 30,90	<b>3504</b> € 181,90
C	white		<b>Order-No.</b> 3409 Price € 31,90	<b>3505</b> € 189,50
C	black/daylight fluorescent		<b>Order-No.</b> 3410 Price € 35,00	-
C	black/luminescent		<b>Order-No.</b> 3411 Price € 48,90	-
C	black		<b>Order-No.</b> 3412 Price € 29,50	<b>3508</b> € 173,90
CC	black/yellow		<b>Order-No.</b> 3401 Price € 25,00	<b>3497</b> € 147,35
CC	red/white		<b>Order-No.</b> 3402 Price € 29,50	<b>3498</b> € 176,00
CC	white		<b>Order-No.</b> 3403 Price € 30,90	<b>3499</b> € 183,90
CC	black		<b>Order-No.</b> 3406 Price € 28,50	<b>3502</b> € 168,50
D	black/yellow		<b>Order-No.</b> 3383 Price € 29,60	<b>3479</b> € 158,40
D	red/white		<b>Order-No.</b> 3384 Price € 39,50	<b>3480</b> € 217,50
D	white		<b>Order-No.</b> 3385 Price € 40,95	<b>3481</b> € 226,00
D	black		<b>Order-No.</b> 3388 Price € 37,50	<b>3484</b> € 207,50
F	black/yellow		<b>Order-No.</b> 3395 Price € 25,85	<b>3491</b> € 151,80
F	red/white		<b>Order-No.</b> 3396 Price € 30,90	<b>3492</b> € 182,00
F	white		<b>Order-No.</b> 3397 Price € 31,90	<b>3493</b> € 189,50
F	black		<b>Order-No.</b> 3400 Price € 29,50	<b>3496</b> € 173,90
S	black/yellow		<b>Order-No.</b> 3389 Price € 54,50	-
S	red/white		<b>Order-No.</b> 3390 Price € 54,50	-
S	white		<b>Order-No.</b> 3391 Price € 54,50	-
S	black		<b>Order-No.</b> 3394 Price € 54,50	-

# Plans for Safety Identification



The displayed information for employees and visitors in buildings is an integral part of safety identification. For this reason, our qualified inhouse CAD department specialises in preventive fire protection. We prepare, deliver and install the necessary plans for you in compliance with all relevant laws, regulations, guidelines and standards.

A professional on-site audit is the basis for all plans; a regular inventory check also ensures the safety of your property. According to the technical rule ASR A2.3 „Escape and rescue routes and emergency exits, escape route plans“, all put up plans must always be up-to-date. Any structural or fire protection changes must result in an adjustment of your plans.

We will perform this review for you. If available, the existing plans establish the starting position. If you do not have a floor plan, we will also draw up new plans – which includes surveying the on-site layout with a handheld laser device – as part of our service. Within the context of the property inspection, an expert conducts a variance analysis of your situation. Amongst other things, this analysis takes into consideration

the location of the emergency, rescue and fire fighting equipment, the path of the escape and rescue routes and the safety signage in the building. After all of the important information has been definitively registered, the final alignment with the relevant authorities (e.g. fire brigade, fire protection services, building authorities) can be conducted on request.

Upon approval of the authorities the plans will be handed out in printed or digital form.



# Escape and rescue plan

**In case of fire**  
Stay calm

**1. Report the fire**  
Operate the nearest fire alarm point or, call: **112**  
Who calls?  
What happened?  
How many victims?  
Where is the fire?  
Wait for any questions

**2. Evacuation**  
Alert others  
Close doors and windows  
Follow the escape routes and follow up the instructions

**3. Try to fight the fire**  
Fire extinguisher, hydrant with hose and other firefighting equipments

**In case of emergency**  
Stay calm

**1. Report the accident**  
Phone: **112**  
Who calls?  
What happened?  
How many victims?  
What kind of injury?  
Wait for any questions

**2. First aid**  
Secure the accident scene  
Give first aid  
Follow up instructions

**3. Further measures**  
Brief the emergency services  
Remove spectators

**Legend**

Current position	Emergency exit/ This way
Fire alarm call point	Escape route
Fire extinguisher	First aid
Collection of firefighting equipment	Doctor
Fire hose reel	Evacuation assembly point

Floor: D-Nr.:	D-Nr.:
Draftsman:	Date:
Logo Customer / Object	

## Escape plans

A property's escape and rescue plans are designed for quick orientation so that the fastest and safest path out of danger can be identified. The plans complete the safety identification and increase the level of safety for people in the building. Consulting our on-site audit, we draw up the plans which present a simple, comprehensible of the escape routes and safety signs, fire extinguishers, wall hydrants, pressure detectors, first aid kits, stretchers etc. . They also contain the rules of conduct in accordance with Part A of the German Brandschutzordnung ("Fire safety regulation"), i.e. how to behave in the event of fire or accidents.

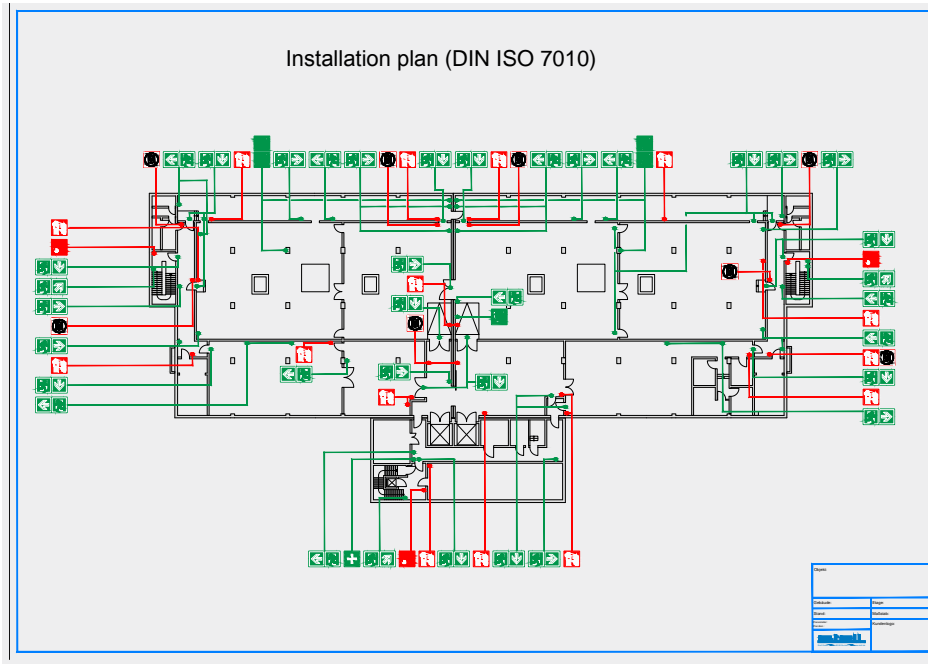

### Installation plans

Within the framework of the on-site audit, we can conduct a variance analysis for the existing labelling or prepare a new documentation of the safety signage if you please. Our expert staff will record all of the signs that are present on your site and note all of the labels that are missing or need to be adapted. We will then create plans for you that include the positioning and fastening of the signs as well as the proper installation options. These plans can be used for an on-site installation by us or your own employees, for documenting your plant, or for further planning of your safety identification.

### Fire safety regulation

The fire safety regulation includes the most important measures to follow for preventing and dealing with fires and is divided in the three following parts. Part A of the fire safety regulation addresses all persons in the relevant building and describes the most important rules in cases of fire or accidents. Part B addresses the employees of the company and, amongst others, describes general measures in order to prevent spread of fire and smoke and guidelines of how to keep clear the escape and rescue routes. The third Part C addresses employees of the company being in charge with fire prevention tasks and mainly describes fire protection measures. The fire safety regulation needs to be individually applied to every building and be checked every other 2 years by a fire prevention expert. Upon request, we can provide you with Part A as individual printouts; these can be complemented with Parts B and C as hardback copy.

### Designs

Upon completion of our work, we give you a data medium that contains the digital documentation in the desired file format (supported file formats: \*.PDF, \*.DWG, \*.DXF). You of course also have the option to use the printing and plotter service. This includes, amongst others, multicolour printing, formats from DIN A4–DIN A0 and special formats upon request, photoluminescent plots (e.g. for escape and rescue plans), and lamination up to DIN A 1. We offer a selection of folding frames in different shapes and sizes. If you are looking for a more appealing variant we recommend the acrylic frames of our own production.

## Preventing fires

No naked flames; fire, unshielded ignition sources and smoking prohibited

## Behaviour in the event of a fire

<b>Keep calm</b>	
<b>Report the fire</b>	Actuate the manual fire alarm Emergency number (0)112
<b>Get to safety</b>	Warn persons at risk / actuate the fire alarm Assist others in need of help Close doors Follow the destined emergency exits Do not use the lift Go to the assembly point Follow instructions
<b>Attempt to extinguish the fire</b>	Use the fire extinguisher Use the fire hose Use means and devices for fire-fighting (e. g. fire blanket)

Fire safety regulations in accordance with DIN 14096 / Object: \_\_\_\_\_ Creation Date: \_\_\_\_\_

# Fastening and Accessories

In order for a sign to aid in providing comprehension, safety and orientation, it must be properly installed. Our fastening products therefore offer the right solution for each of our safety identification systems. Tried, tested and durable, the different sizes and types of signs can be fastened to the necessary installation points in a clearly visible manner. For further questions regarding our products our sales team is always at your disposal.



## Snap frame

Material		Quantity	Article
Aluminium anodized		1 piece	0060
<i>Width x Height x Depth</i>		<i>mitred corner</i>	<i>rounded corner</i> <i>lockable</i> <i>fire protection certified</i>
274 x 361 x 32 mm	DIN A4	<b>Order-No.</b> Price	<b>2731</b> € 27,50
361 x 484 x 32 mm	DIN A3	<b>Order-No.</b> Price	<b>2732</b> € 30,00
484 x 658 x 32 mm	DIN A2	<b>Order-No.</b> Price	<b>2733</b> € 35,00
			<b>2736</b> € 43,50
			<b>47509</b> € 52,00
			<b>47508</b> € 62,00
			<b>47507</b> € 92,00

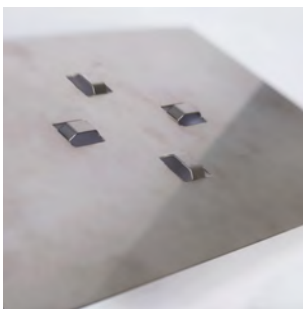

## Sign mount

Material		Quantity	Article
Aluminium <b>A</b> / Stainless steel <b>E</b>		1 piece	0107
<i>Width x Height</i>	<i>Scope of delivery</i>	<b>Order-No.</b> Price	<b>49542</b> € 5,05
145 x 145 mm	incl. double faced adhesive foam tape	<b>A</b>	<b>E</b> <b>36632</b> € 5,35
195 x 295 mm	incl. double faced adhesive foam tape	<b>A</b>	<b>E</b> <b>36633</b> € 11,25

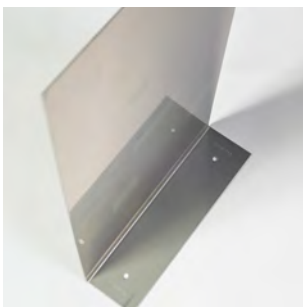

## Flag fastener

Material		Quantity	Article
Aluminium		1 piece	0061
<i>Width x Height</i>	<i>Application</i>	<b>Order-No.</b> Price	<b>2715</b> € 6,65
150 x 150 mm	wall and ceiling suspension	<b>Order-No.</b> Price	<b>2716</b> € 9,85
150 x 300 mm	wall and ceiling suspension	<b>Order-No.</b> Price	<b>2717</b> € 10,50
150 x 450 mm	wall and ceiling suspension	<b>Order-No.</b> Price	<b>2718</b> € 7,44
200 x 200 mm	wall and ceiling suspension	<b>Order-No.</b> Price	<b>2719</b> € 12,71
200 x 400 mm	wall and ceiling suspension	<b>Order-No.</b> Price	<b>2720</b> € 16,90
200 x 600 mm	wall and ceiling suspension	<b>Order-No.</b> Price	<b>2721</b> € 8,98
300 x 150 mm	wall suspension	<b>Order-No.</b> Price	<b>2722</b> € 11,58
400 x 200 mm	wall suspension		

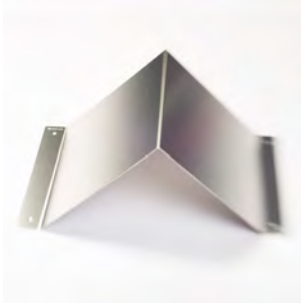

### Nose fastener

Material	Quantity	Article
Aluminium	1 piece	0062
<i>Width x Height</i>		
150 x 150 mm	<b>Order-No.</b> 2701 Price € 9,50	
150 x 300 mm	<b>Order-No.</b> 2702 Price € 11,20	
200 x 200 mm	<b>Order-No.</b> 2704 Price € 10,80	
200 x 400 mm	<b>Order-No.</b> 2705 Price € 13,80	
200 x 600 mm	<b>Order-No.</b> 2706 Price € 16,85	
300 x 300 mm	<b>Order-No.</b> 2703 Price € 14,60	
400 x 400 mm	<b>Order-No.</b> 2707 Price € 19,90	



### Double-faced acrylate adhesive tape

Material	Quantity	Article
Acryl	1 piece	0063
<i>Width x Length</i>		
150 mm x 50 m	<b>Order-No.</b> 2699 Price € 156,00	
200 mm x 50 m	<b>Order-No.</b> 2700 Price € 208,00	



### Double faced adhesive foam tape

Material	Quantity	Article
Polyethylene foam	1 piece	0021
<i>Width</i>	<i>Application</i>	<i>Length 10 m</i> <i>Length 50 m</i>
150 mm	For signs	<b>Order-No.</b> 6860 <b>94</b> Price € 42,00   € 199,50
200 mm	For signs	<b>Order-No.</b> 6861 <b>95</b> Price € 55,50   € 267,00
300 mm	For signs	<b>Order-No.</b> 6862 <b>96</b> Price € 83,00   € 399,00
400 mm	For signs	<b>Order-No.</b> 6863 <b>97</b> Price € 107,00   € 529,50
58 mm	For flat profiles	<b>Order-No.</b> 6858 <b>98</b> Price € 18,00   € 88,00
78 mm	For flat profiles	<b>Order-No.</b> 6859 <b>99</b> Price € 23,00   € 99,00
51 mm	For sloped profiles	<b>Order-No.</b> 6864 <b>6865</b> Price € 17,00   € 83,50
71 mm	For sloped profiles	<b>Order-No.</b> 6866 <b>6867</b> Price € 22,80   € 110,00



### Cartridge skeleton gun

	Quantity	Article
	1 piece	0091

*Application*

For adhesives and sealants from the cartridge

<b>Order-No.</b>	<b>5456</b>
Price	€ 12,00



### Tube of glue

	Quantity	Article
	1 piece	0091

*Design*

Cartridge, 310 ml

*Application*

For the assembly of signs, transparent

<b>Order-No.</b>	<b>47477</b>
Price	€ 16,00



### Cleaner spray

	Quantity	Article
	1 piece	0091

*Design*

Spray can, 500 ml

*Application*

For degreasing metallic surfaces, glass and ceramics (check suitability before use)



### Surface cleaner

	Quantity	Article
	1 piece	0091

*Design*

Spray can, 500 ml

*Application*

For cleaning heavily soiled surfaces

<b>Order-No.</b>	<b>33848</b>
Price	€ 6,50

## Terms and Conditions

### 1. General

**1.1** The following "Terms and Conditions – Purchase Contract", in here later referred to as "terms and conditions", apply to all purchase contracts between the Stell GmbH (Limited liability company), Raiffeisenring 35-37, 46395 Bocholt, Deutschland (in here later referred to as "seller") and enterprises according to § 14 BGB, legal bodies under public law and legal assets under public law (in here later referred to as "buyer").

**1.2** Contradicting or differing terms and conditions of the buyer are no subject to the contract even if the seller is fulfilling the contract without having explicitly refused those terms. Differing terms only apply if explicitly agreed to by the seller in writing.

### 2. Contract proposal and conclusion, offers, orders

**2.1** The offers of the seller are non-binding and shall be considered as a proposal towards the buyer to place a purchase order with the seller. The purchase contract (in here later referred to as "order") is concluded with the placement of the order by the buyer and the acceptance of the order by the seller. If the acceptance notice differs from the order, it is to be considered a new, non-binding offer of the seller.

**2.2** By placing the order the buyer bindingly declares to willingly purchase the ordered products. The seller is entitled to accept the offer for the order within 2 weeks after the placement of the order. By placing the order, the buyer agrees to the present terms and conditions. The same applies to all future purchase orders even if the terms and conditions are not explicitly referred to.

**2.3** The buyer is obligated to immediately revise the acceptance notice/ order confirmation of the seller. If no formal acceptance notice has been issued, the former applies also to instalments, partial or final accounts.

**2.4** The granting of a certain property or suitability of the ordered product concerning a certain intended use as well as taking over a guarantee is only binding if confirmed by the seller in writing. The properties of patterns or samples are only binding as long as explicitly agreed to be properties of the product.

**2.5** As far as the seller provides advice and support services, those are provided to the best of his/her knowledge.

### 3. Purchase price, payment, default, off-set, retention, transfer of claims

**3.1** (a) All prices are ex office of the seller.  
(b) Generally, the purchase price is excluding present statutory VAT as far as legal tax obligations apply. If the statutory VAT rate increases between the conclusion of the contract and the issuance of the invoice, the buyer has to pay the higher VAT rate.

(c) On deliveries within the EU, the buyer has to provide his/her VAT ID number used for his/her turnover taxation prior to the payment. For non-electronic export declarations concerning deliveries from the Federal Republic of Germany to countries outside of the EU which are not carried out or initiated by the seller, the buyer has to provide the export declaration necessary for taxation. If the export declaration is not provided, the buyer has to pay the VAT for the products in addition to the invoiced amount for deliveries within Germany.  
(d) The seller is entitled to claim down payments according to the value of already performed partial deliveries.

**3.2** If the agreed delivery term exceeds 4 months, the seller reserves the right to reasonably adapt the agreed purchase price according to changes of actual costs, including material costs and labor expenses as well as shipping costs if necessary. The same applies in case of increase of customs or fees required for deliveries at the seller's expense. If the price not proportionally increases compared to the consumer price index, the price increase will be limited to the market price. Paragraph 4.12 remains untouched.

**3.3** The agreed purchase price is due within 7 days after the delivery of the product to the buyer without deductions, unless otherwise agreed upon. The same applies to partial deliveries. Trade discounts may only be deducted if the payment has been credited to the seller's account in due time and if the buyer is not in default with other claims of the seller at the time of the respective payment. Trade discounts may only be deducted from the net price.

**3.4** Drafts and checks will only be accepted on account of performance and upon explicit agreement. They will not be considered as payment until

they are encashed. Draft charges and taxes are at the buyer's expense after the expiry of the agreed payment term.

**3.5** The buyer defaults in payment after the expiry of the 7th day after the delivery of the product, latest after expiry of the last day of an individually granted payment period.

**3.6** (a) The buyer may only off-set against claims of the seller with undisputed, final and absolute counter claims.

(b) Letter (a) respectively applies to the execution of retention rights by the buyer.

**3.7** The buyer is not entitled to retain claims of the seller resulting from this contract due to unsettled claims not subject to this contract. **3.8** The buyer's right to lien according to § 369 HGB does not apply.

**3.9** If there are reasonable doubts concerning the liquidity or credit status of the buyer and if the buyer is not willing to pay in advance or provide a suitable financial security on demand of the seller, the seller is entitled, if he/she has not performed yet, to demand an advanced cash payment before a possible further/subsequent delivery. This particularly applies to agreed, but not yet carried-out subsequent business transactions.

**3.10** The seller reserves the right to use payments to settle the oldest open account item plus incurred default interests according to the following order: costs, interests, principle claim.

**3.11** The seller is entitled to transfer claims resulting from or in relation to this purchase contract. The buyer may not transfer his claim against the seller to third parties. § 354a HGB remains unchallenged.

**3.12** On default of payment of remuneration claims, the seller is entitled to claim default interest of 8 %-points above the basic interest rate according to § 247 BGB valid at the time of default occurrence. § 352 HGB as well as claims towards further actual default damages remain unchallenged, so do legal rights to claim damages for the failure of performance as well as withdrawal from the contract.

**3.13** On default, all claims resulting from all contract relationships of the parties are due immediately, unless the default is related to only minor claims.

### 4. Delivery, transfer of risk

**4.1** If no explicit delivery term has been stated by the seller, the delivery may be claimed not until 8 weeks after the conclusion of the contract. An agreed approximate delivery term does not begin until receipt of all necessary documentations and information to be handed in by the buyer (P&IDs, specifications, production lists, approval of layouts).

**4.2** If the buyer has been granted a certain delivery period, this period is to be considered as complied with if the product to be delivered has been delivered to the customer. If the purchase contract consists of several partial deliveries, the acceptance has to take place according to the agreed delivery intervals.

**4.3** If not otherwise agreed upon, the products are provided for delivery at the seller's place of business. On collection from the delivery point the collection has to take place by the buyer or his/her representatives according to legal regulations concerning secure loading of vehicles.

**4.4** If a dispatch of products has been agreed upon, the seller dispatches the products on request of the buyer according to § 447 BGB at the buyer's risk and expense.

**4.5** If employees of the seller support the loading of vehicles according to paragraphs 4.3, 4.4 outside the scope of agreed services on request of the buyer, they solely act on behalf of the buyer.

**4.6** (a) The risk transfers latest on handing over the product to the forwarding/collecting agent according to paragraph 4.3, also in the event of partial deliveries or if the seller has taken over additional services, such as dispatch or direct delivery of the products. On request of the buyer, the shipment will be insured against theft, physical, fire or water damages and other insurable risks by the seller acting as a mediator only.

(b) If the buyer defaults in acceptance, the seller is entitled to store the products without further notice/reminders at the buyer's expense and risk.  
(c) If the buyer defaults in acceptance, the purchase price is due immediately.

**4.7** Partial deliveries by the seller are accepted, if reasonable to the buyer under consideration of the interest of both parties.

**4.8** The acceptance of the shipment without objections by the forwarding/collecting agent is to be considered proof of intact packaging and correct loading, unless the buyer proves that the packaging was damaged or the loading did not take place correctly on handing over the shipment to the

forwarding/collecting agent. Complaints due to transport damages are to be reported immediately to the company in charge of the shipment with a copy to the seller.

**4.9** If the parties use INCOTERMS clauses for an individual purchase contract, those terms apply in the version valid at the time of concluding the contract. Possible contradictions with other terms of paragraph 4 of this agreement are overruled by the agreed INCOTERMS regulations.

**4.10** The buyer is responsible for the compliance with legal and official regulations concerning import, delivery, storage and use of the services and deliveries performed by the seller in the country or place of destination as well as in the transit countries as well as responsible for the acquisition of required import and transit documents (custom etc.) as long as those are not exclusively to be provided by the seller due to legal reasons.

**4.11** All deliveries are subject to correct and due supply of the seller.

**4.12** If it has been exceptionally agreed upon that the seller is to bear custom or export/import costs of the country of origin/destination or of transit countries, the cost increase occurring in between the time of the acceptance of order and delivery of the contractual products transfers to the buyer.

### 5. Reservation of title

**5.1** Products remain property of the seller until complete payment of all receivables resulting from the business relationship with the buyer are settled.

**5.2** The reservation of title also persists if single claims of the seller are added to a running account and the account is balanced and confirmed.

**5.3** The return of reserved products does only represent a withdrawal from the contract, if explicitly declared by the seller in writing. If the seller withdraws from the contract, he/she may claim a reasonable compensation for the duration the products were in possession of and in use by the buyer.

**5.4** (a) The buyer is entitled to use the products owned by the seller in the usual course of business as long as he/she complies with his/her duties resulting from the business relationship with the seller. Not included in the usual course of business is the transfer of claims concerning the purchase price from the buyer to his customer(s); in particular: pawning, mortgage or other encumbrances of the products are prohibited.

(b) All claims of the buyer resulting from the resale of products owned by the seller are already by now transferred to the seller for security reasons, if applicable in the amount of the co-ownership share. Confirmed receivables resulting from current account agreements the buyer already transfer to the seller at the time of concluding the contract with the seller in the amount of accounts receivable. If the buyer defaults in payment, the seller is entitled to claim the interim return of the products owned by the seller even without withdrawing from the contract and setting an additional grace period at the buyer's expense.

(c) In the event of processing of products owned by the seller, the seller is to be considered the manufacturer and gains a co-ownership proportionally to the invoiced value of his own products.

(d) If the product of the buyer is to be considered the final product in the event of attaching or blending of products owned by the seller with goods of the buyer, the co-ownership of the product transfers to the seller in the amount of the invoiced value of his/her own product or the current market value of the final product, if an invoiced value is not existent. In these cases the buyer is to be considered the custodian of the product.

**5.5** In the event of resale of products owned by the seller, the buyer is obligated to arrange regulations concerning the reservation of title with his customers without revealing the original reservation of title agreed upon with the seller. (Secondary reservation of title)

**5.6** If the seller has reasonable concerns that the buyer is not fulfilling or will not fulfil his/her duties towards the seller, the buyer is to order his/her customers on demand of the seller to abstain from demands to receiving information about the stock of seller-owned products and receivables transferred to the seller as well as to being handed out documents to enforce transferred receivables. The same applies in case of withdrawal of the direct debit authorization. Access to reserved products by third parties and transferred receivables is to be announced immediately.

**5.7** If the security value exceeds the claims of the seller by more than 10 %, the seller will release securities on the buyer's request.

### 6. Warranty, Guarantee

**6.1** If not individually agreed upon, the seller delivers the product according to the terms stated in the regular product description (catalogues etc.), otherwise according to standard quality. Additional properties of the product to be purchased stated in other publications or advertisements of the seller or his/her suppliers/manufacturers may not be derived by the buyer unless the seller has confirmed those additional properties in writing. Guarantees require an explicit written confirmation by the company management of the seller.

**6.2** Subject to compliance with inspection and objection obligations of the buyer according to Section 377 German Commercial Code (HGB) in connection with paragraph 6.3 of this agreement, the seller may choose to compensate for defective products between rectification of the defect or new delivery. The seller reserves the right of two rectification attempts. The seller is entitled to reject the chosen rectification method if rectification would result in unproportionally high costs and the other method of rectification is possible without significant disadvantages for the buyer. If the rectification fails, the buyer is entitled either to claim a reduction of the purchase price or to withdraw from the contract. The right of the buyer to legally claim compensation for damages or necessary expenses according to the law, in addition to withdrawing from the contract, remains unchallenged, except the limitations for claims of the buyer according to paragraph 7 of this agreement.

**6.3** The defect notice according to Section 377 German Commercial Code (HGB) may only be issued by the buyer in writing. Further legal requirements according to Section 377 German Commercial Code (HGB) remain unchallenged. Regardless of that, guarantee claims of the buyer are excluded if the buyer fails to report obvious defects in writing within one week from the date of delivery until dispatch of the written defect notice.

**6.4** The delivery of defect-free product for the purpose of rectification generally takes place only in exchange to the return of the defective product.

### 7. Liability

In cases of contractual or non-contractual liability, the seller compensates for damages or lost expenses according to the following regulations:

**7.1** The seller is liable to the full amount in cases of intent or gross negligence.

**7.2** On lack of a property for whose existence the seller has taken over a guarantee or which has been assured to the buyer, the seller is liable for the typical, foreseeable damage which was supposed to be prevented through the guarantee or assurance as long as the lack of the guaranteed/assured property was caused by intent or gross negligence.

**7.3** In case of light negligent violation of essential contractual obligations (cardinal obligations), the liability of the seller is limited to the compensation for the typical, foreseeable damage; in case of light violation of non-cardinal obligations, liability of the seller is excluded.

**7.4** The above mentioned limitations of liability do not apply to claims of the buyer under the Product Liability Act and resulting from harm to life, body and health caused by the seller.

**7.5** Other legal obligations concerning compensation or exclusion of liability, such as Section 281, paragraph 1, sentence 3 German Civil Code (BGB) remain unchallenged.

### 8. Force Majeure

In case of events or circumstances, such as natural events, war, labor disputes, raw material and energy shortage, traffic and facilities disturbances, fire and explosion damages, orders of higher authorities whose occurrence are outside the sphere of influence of the seller, even under consideration of careful commercial planning and precaution, and which impair the availability of products from the source from which the seller is supplied so that the seller is not able to fulfil his/her contractual duties (under partial consideration of other internal and external delivery obligations), the seller is (i) relieved from his/her contractual duties for the duration and extend of the disturbance and (ii) is not obligated to obtain the products from third parties. Sentence 1 also applies as long as the events and circumstances make the execution of the respective business sustainably uneconomic for the seller or influence the seller's suppliers. If those events last longer than 3 months the seller is entitled to withdraw from the contract.

### 9. Confidentiality, data protection

**9.1** The parties agree to treat all confidential information and industrial secrets of the other party collected within the scope of execution of the con

tract confidentially without temporal limits and to use them only within the scope of executing the contract.

**9.2** Both parties comply with data protection regulations. The handling of the business relationship will be supported by a data processing system of the seller, thus data of the buyer will be automatically collected and stored. The buyer will be informed about the storage of his/her data.

**10. Industrial property rights**

**10.1** The buyer is responsible that property rights of third parties are not violated by the seller receiving and using materials of the buyer, such as documentations, data, drafts, planes or other execution instructions provided by the buyer necessary for the execution of the contract, and relieves the seller from all related claims. The buyer bears license fees or costs resulting from the avoidance of such violations of property rights.

**10.2** If industrial property rights occur within the scope of the execution of contractual agreements, the buyer is to transfer those rights to the seller if legally possible. If the full transfer of rights is not possible, the buyer grants the seller an exclusive, over-all usage right, unlimited in time and space or, if even this is not possible, a non-exclusive right. Legal regulations which grant the buyer a reasonable compensation for the transfer of rights remain unchallenged.

**10.3** The buyer has no property rights towards films, plans, drawings and graphics compiled in the course of the preparation of purchase product. In particular, industrial property rights on those as well as on the contractual products remain with the seller. By full payment of the remuneration, the buyer gains the ownership on the delivered products.

**10.4** The seller is entitled to perform or deliver products to third parties, comparable to the products delivered to or compiled for the buyer, in particular films, plans, drawings and graphics. The

seller is entitled to attach an adequate copyright label or label of origin to all contractual products.

**10.5** The seller is entitled to use the purchase of products delivered to the buyer within reason for own advertising and promotion purposes in any form, such as illustrations of products and the place of use at the buyer's facilities in brochures or electronic media. This right does only not apply if the buyer explicitly disagrees to such use by the time of his/her declaration of intent towards concluding the contract.

**11. Place of execution, place of jurisdiction, choice of law, severability clause, written form**

**11.1** Place of payments by the buyer is the company residence of the seller.

**11.2 (a)** Place of jurisdiction for all claims resulting from or in relation to the respective purchase contract, concerning its conclusion, its effectiveness and execution is the usual place of jurisdiction of the seller or, on request of the seller, the usual place of jurisdiction of the buyer.

(b) If the buyer has his/her residence outside of the EU, all law suits resulting from or in relation to the respective purchase contract, concerning its conclusion, its effectiveness and execution are carried out according to the arbitration regulations of the German Institution for Arbitration (DIS) under exclusion of the legal recourse. Decisions are made by a single arbitrator who has to have a qualification to judgeship and is appointed according to Section 14 of the German DIS Arbitration Code. The place of arbitration is the place of residence of the seller. The language of arbitration is German. The gathering of evidence takes place under application of the valid regulations of the German Civil Code concerning the gathering of evidence.

**11.3** German law is applied under exclusion of CISG law (United Nations Convention on Contracts for the International Sale of Goods) as well as the referral regulations of the German International

Civil Law.

**11.4** If single regulations of these terms of service are entirely or partially invalid or have legal gaps, the effectiveness of other regulations or parts of regulations remains unchallenged.

**11.5** The German version of these terms of service is legally determinative. The publication of a version in another language takes only place for the purpose of easier comprehension.

## Your contact persons

for all questions regarding labelling and signs

Sometimes a personal conversation is the best choice. Do you need an individual solution? Do you work with a standard other than DIN? Or maybe you are just seeking professional advice? Please do not hesitate and get in contact with our industry experts!



**Markus Bauhaus**

Key Account Manager  
Chemical  
Phone +49 2871 7002-218  
m.bauhaus@stell.de



**Christiaan Bruining**

Head of Global Sales & Projects  
Phone +49 2871 7002-551  
bruining@stellsignprojects.com



**Stefan Röhl**

Key Account Manager  
Energy/Industrial/Fire protection  
Phone +49 2871 7002-206  
roehl@stell.de



**Stell GmbH**  
Raiffeisenring 35-37  
46395 Bocholt  
Germany  
Phone +49 2871 7002-0  
Fax +49 2871 7002-272  
info@stell.com

[stell.com](http://stell.com)

**stell**